



Grandstream Networks, Inc.

GXP1160/GXP1165

Small-Medium Business IP Phone



GXP1160/GXP1165 User Manual

Index

GUI INTERFACE EXAMPLES.....	5
GNU GPL INFORMATION.....	6
CHANGE LOG	7
FIRMWARE VERSION 1.0.6.7	7
FIRMWARE VERSION 1.0.5.58	7
FIRMWARE VERSION 1.0.5.32	7
FIRMWARE VERSION 1.0.5.26	7
FIRMWARE VERSION 1.0.5.24	7
FIRMWARE VERSION 1.0.5.15	8
FIRMWARE VERSION 1.0.5.2	8
WELCOME.....	9
PRODUCT OVERVIEW.....	10
FEATURE HIGHLIGHTS	10
GXP1160/GXP1165 TECHNICAL SPECIFICATIONS	10
INSTALLATION.....	12
EQUIPMENT PACKAGING	12
CONNECTING YOUR PHONE	12
SAFETY COMPLIANCES.....	14
WARRANTY.....	14
USING THE GXP1160/GXP1165.....	15
GETTING FAMILAR WITH THE LCD	15
GETTING FAMILAR WITH THE KEYPAD.....	17
MAKING PHONE CALLS.....	18
<i>HANDSET, SPEAKER AND HEADSET MODE</i>	<i>18</i>
<i>2 CALLS WITH 1 SIP ACCOUNT.....</i>	<i>18</i>
<i>COMPLETING CALLS.....</i>	<i>18</i>
<i>MAKING CALLS USING IP ADDRESSES</i>	<i>20</i>
ANSWERING PHONE CALLS	22
<i>RECEIVING CALLS.....</i>	<i>22</i>

<i>DO NOT DISTURB</i>	22
DURING A PHONE CALL.....	22
<i>CALL WAITING/CALL HOLD</i>	22
<i>MUTE</i>	23
<i>CALL TRANSFER</i>	23
<i>3-WAY CONFERENCING</i>	24
<i>VOICE MESSAGES (MESSAGE WAITING INDICATOR)</i>	26
CALL FEATURES	26
CUSTOMIZED LCD SCREEN & XML	28
CONFIGURATION GUIDE.....	29
CONFIGURATION VIA KEYPAD	29
CONFIGURATION VIA WEB BROWSER	34
DEFINITIONS	35
<i>STATUS PAGE DEFINITIONS</i>	35
<i>ACCOUNTS PAGE DEFINITIONS</i>	36
<i>SETTINGS PAGE DEFINITIONS</i>	45
<i>NETWORK PAGE DEFINITIONS</i>	49
<i>MAINTENANCE PAGE DEFINITIONS</i>	51
<i>PHONEBOOK PAGE DEFINITIONS</i>	54
NAT SETTINGS	56
WEATHER UPDATE	57
PUBLIC MODE	58
EDITING CONTACTS AND CLICK-TO-DIAL	58
UPGRADING AND PROVISIONING	61
UPGRADE VIA KEYPAD MENU	61
UPGRAGE VIA WEB GUI.....	61
NO LOCAL TFTP/HTTP SERVERS	62
CONFIGURATION FILE DOWNLOAD	62
RESTORE FACTORY DEFAULT SETTINGS	64
EXPERIENCING THE GXP1160/GXP1165	65

Table of Tables
GXP1160/GXP1165 User Manual

Table 1: GXP1160/GXP1165 TECHNICAL SPECIFICATIONS.....	10
Table 2: GXP1160/GXP1165 EQUIPMENT PACKAGING	12
Table 3: GXP1160/GXP1165 CONNECTORS	12
Table 4: LCD DISPLAY DEFINITIONS.....	15
Table 5: GXP1160/GXP1165 LCD ICONS	16
Table 6: KEYPAD DEFINITIONS	17
Table 7: CALL FEATURES.....	26
Table 8: CONFIGURATION MENU	29

Table of Figures
GXP1160/GXP1165 User Manual

Figure 1: GXP1160/GXP1165 Ports.....	12
Figure 2: GXP1160/GXP1165 Pin-out.....	13
Figure 3: Keypad MENU Flow.....	33
Figure 4: Weather Update	57
Figure 5: Web GUI - Phonebook->Contacts	59
Figure 6: Click-to-Dial.....	60

GUI INTERFACE EXAMPLES

http://www.grandstream.com/products/gxp_series/general/documents/gxp21xx_gui.zip

1. Screenshot of Login Page
2. Screenshots of Status Pages
3. Screenshots of Accounts Pages
4. Screenshots of Settings Pages
5. Screenshots of Network Pages
6. Screenshots of Maintenance Pages
7. Screenshots of Phonebook Pages

GNU GPL INFORMATION

GXP1160/GXP1165 firmware contains third-party software licensed under the GNU General Public License (GPL). Grandstream uses software under the specific terms of the GPL. Please see the GNU General Public License (GPL) for the exact terms and conditions of the license.

Grandstream GNU GPL related source code can be downloaded from Grandstream web site from:
http://www.grandstream.com/support/faq/gnu_gpl.

CHANGE LOG

This section documents significant changes from previous versions of user manuals for GXP1160/GXP1165. Only major new features or major document updates are listed here. Minor updates for corrections or editing are not documented here.

FIRMWARE VERSION 1.0.6.7

- No new feature added.

FIRMWARE VERSION 1.0.5.58

- Added “3CX Auto Provision” under Maintenance. [MAINTENANCE PAGE DEFINITIONS]
- Added “Second Dial Tone” under Settings. [SETTINGS PAGE DEFINITIONS]
- Added “Sort Phonebook by” under Phonebook Management.[PHONEBOOK PAGE DEFINITIONS]
- Added “Public Mode Login Expiration” under Settings. [SETTINGS PAGE DEFINITIONS]
- Added “Hold Method” under Account setting. [ACCOUNTS PAGE DEFINITIONS]
- Added “Crypto Life Time” under Account setting. [ACCOUNTS PAGE DEFINITIONS]
- Added “UCM Connection” under LCD Main menu.[CONFIGURATION VIA KEYPAD]

FIRMWARE VERSION 1.0.5.32

- Added “Web Access Mode” under Security setting. [SECURITY]
- Replaced “Disable Telnet” under Web Access by “Disable SSH” under Security setting page. [SECURITY]

FIRMWARE VERSION 1.0.5.26

- Added “Phonebook Key function” feature under Phonebook Management settings. [PHONEBOOK PAGE DEFINITION]
- Added “Blink message LED on ringing” feature in Call Features. [CALL FEATURES]

FIRMWARE VERSION 1.0.5.24

- Updated TFTP server download link for 1.0.5.24. [NO LOCAL TFTP/HTTP SERVERS]
- Added “Enable LLDP” feature under Network settings. [NETWORK PAGE DEFINITIONS]

FIRMWARE VERSION 1.0.5.15

- Updated Web GUI interface examples with new screenshots for 1.0.5.15. [GUI INTERFACE EXAMPLES]
- Add pin-out information. [Figure 2: GXP1160/GXP1165 Pin-out]
- Updated Auto Attended Transfer information. [CALL TRANSFER]
- Modified Public Mode information. [PUBLIC MODE]
- Updated Click-To-Dial feature information. [EDITING CONTACTS AND CLICK-TO-DIAL]
- Updated Keypad MENU options and Keypad configuration flow. [CONFIGURATION VIA KEYPAD]
- Updated Web GUI options. [DEFINITIONS]

FIRMWARE VERSION 1.0.5.2

This is the initial version.

WELCOME

Thank you for purchasing Grandstream GXP1160/GXP1165 Small-Medium Business IP Phone. GXP1160/GXP1165 is a next generation small-to-medium business IP phone that features single SIP account, up to 2 call appearances, a 128 x 40 graphical LCD, 3 XML programmable context-sensitive soft keys, dual network ports with integrated PoE (GXP1165 only), 3-way conference, and Electronic Hook Switch (EHS) with Plantronics headset. The GXP1160/1165 delivers superior audio quality, rich and leading edge telephony features, personalized information and customizable application service, automated provisioning for easy deployment, advanced security protection for privacy, and broad interoperability with most 3rd party SIP devices and leading SIP/NGN/IMS platforms. It is a perfect choice for small-to-medium businesses looking for a high quality, feature rich IP phone with highly affordable cost.

Caution:

Changes or modifications to this product not expressly approved by Grandstream, or operation of this product in any way other than as detailed by this User Manual, could void your manufacturer warranty.

Warning:

Please do not use a different power adaptor with the GXP1160/GXP1165 as it may cause damage to the products and void the manufacturer warranty.

This document is subject to change without notice. The latest electronic version of this user manual is available for download here:

<http://www.grandstream.com/support>

Reproduction or transmittal of the entire or any part, in any form or by any means, electronic or print, for any purpose without the express written permission of Grandstream Networks, Inc. is not permitted.

PRODUCT OVERVIEW

FEATURE HIGHLIGHTS

- 128 x 40 pixel graphical LCD display;
- Single SIP account, up to 2 call appearances, 3 XML programmable context-sensitive soft keys, 3-way conference;
- Phonebook with up to 500 contacts and call history with up to 500 records;
- Automated personal information service (e.g., local weather), personalized music ring tone/ring back tone;
- Dual switched auto-sensing 10/100Mbps network ports, integrated PoE (GXP1165 only);
- Automated provisioning using TR-069 or AES encrypted XML configuration file, SRTP and TLS for advanced security protection, 802.1x for media access control.

GXP1160/GXP1165 TECHNICAL SPECIFICATIONS

Table 1: GXP1160/GXP1165 TECHNICAL SPECIFICATIONS

Protocols and Standards	SIP RFC3261, TCP/IP/UDP, RTP/RTCP, HTTP/HTTPS, ARP/RARP, ICMP, DNS (A record, SRV, NAPTR), DHCP, PPPoE, TELNET, TFTP, NTP, STUN, SIMPLE, TR-069, 802.1X, LLDP, LLDP-MED, LDAP, IPv6, TLS, SRTP
Network Interfaces	Dual switched 10/100Mbps port, integrated PoE (GXP1165 only)
Graphic Display	128 x 40 graphical LCD display
Feature Keys	1 SIP account, 3 XML programmable context sensitive soft keys, 5 Navigation/Menu/Volume keys, 9 dedicated function keys for PHONEBOOK, MESSAGE (with LED indicator), HOLD, TRANSFER, CONFERENCE, FLASH, SPEAKERPHONE, VOLUME, SEND/REDIAL
Voice Codec	Support for G.723.1, G.729A/B, G.711u/a, G.726-32, G.722 (wide-band), iLBC, in-band and out-of-band DTMF (in audio, RFC2833, SIP INFO)
Telephony Features	Hold, transfer, forward, 3-way conference, downloadable phone book (XML, LDAP, up to 500 items), call waiting, call log (up to 500 records), off-hook auto dial, auto answer, click-to-dial, flexible dial plan, hot-desking, personalized music ringtones, server redundancy and fail-over
HD Audio	Yes, HD handset with support for wideband audio
Headset Jack	RJ9, supporting Electronic Hook Switch (EHS) with Plantronics headsets
Base Stand	Yes, 1 angle position available

Wall Mountable	Yes
QoS	Layer 2 (802.1Q, 802.1p) and Layer 3 (ToS, DiffServ, MPLS) QoS
Security	User and administrator level passwords, MD5 and MD5-sess based authentication, 256-bit AES encrypted configuration file, TLS, SRTP, 802.1X media access control
Multi-language	English, German, Italian, French, Spanish, Portuguese, Russian, Croatian, Simplified Chinese, traditional Chinese, Korean, Japanese and etc
Upgrade and Provisioning	Firmware upgrade via TFTP/HTTP/HTTPS, mass provisioning using TR-069 or AES encrypted XML configuration file
Power and Green Energy Efficiency	Universal power adapter: Input: 100-240VAC 50-60Hz; Output: 5VDC, 800mA Integrated Power-over-Ethernet (Built-in auto-sensing: Cisco and IEEE 802.3af standard) Max power consumption 2.5W (power adapter) or 3W (PoE)
Physical	Unit dimension: 154mm (W) x 200mm (L) x 79mm (D) (handset onhook) Unit weight: 0.6kg Package weight: 1.03kg
Operating Temperature and Humidity	Operating: 32-104 °F / 0-40 °C, 10-90% (non-condensing) Storage: 14-140 °F / -10-60 °C
Package Content	GXP1160/GXP1165 phone, handset with cord, base stand, universal power supply, network cable, quick start guide
Compliance	FCC Part 15 (CFR 47) Class B; EN55022 Class B, EN55024, EN61000-3-2, EN61000-3-3, EN60950-1; AS/NZS CISPR 22 Class B, AS/NZS CISPR 24, RoHS; UL 60950 (power adapter)

INSTALLATION

EQUIPMENT PACKAGING

Table 2: GXP1160/GXP1165 EQUIPMENT PACKAGING

Main Case	Yes	1
Handset	Yes	1
Phone Cord	Yes	1
Power Adaptor	Yes	1
Ethernet Cable	Yes	1
Phone Stand	Yes	1
Quick Start Guide	Yes	1

CONNECTING YOUR PHONE

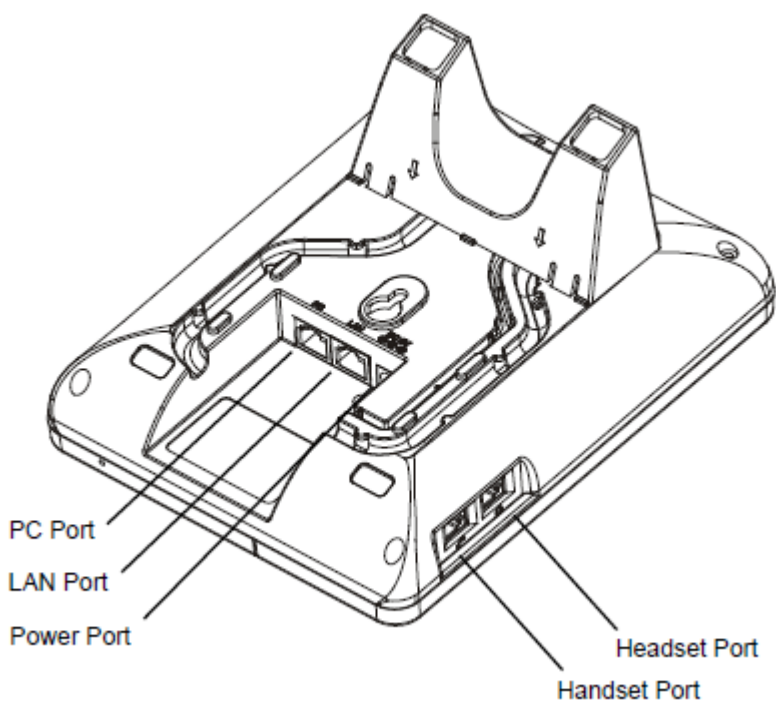

Figure 1: GXP1160/GXP1165 Ports

Table 3: GXP1160/GXP1165 CONNECTORS

Handset Port	RJ9
Headset Port	RJ9 headset connector port, supporting EHS (Electronic Hook-Switch) with Plantronics headsets
LAN Port	10/100Mbps RJ-45 port connecting to Ethernet, integrated PoE (GXP1165 only)
PC Port	10/100Mbps RJ-45 port for PC connection
Power Jack	5V DC Power connector port

To set up the GXP1160/GXP1165, follow the steps below:

1. Attach the phone stand to the back of the phone where they are slots;
2. Connect the handset and main phone case with the phone cord;
3. Connect the LAN port of the phone to the RJ45 socket of a hub/switch or a router (LAN side of the router) using the Ethernet cable;
4. Connect the 5V DC output plug to the power jack on the phone; plug the power adapter into an electrical outlet. If PoE switch is used on GXP1165 in step 3, this step could be skipped;
5. The LCD will display provisioning or firmware upgrade information. Before continuing, please wait for the date/time display to show up;
6. Using the keypad configuration menu or phone's embedded web server (Web GUI) by entering the IP address in web browser, you can further configure the phone.

Please see below the pin-out information for GXP1160/GXP1165.

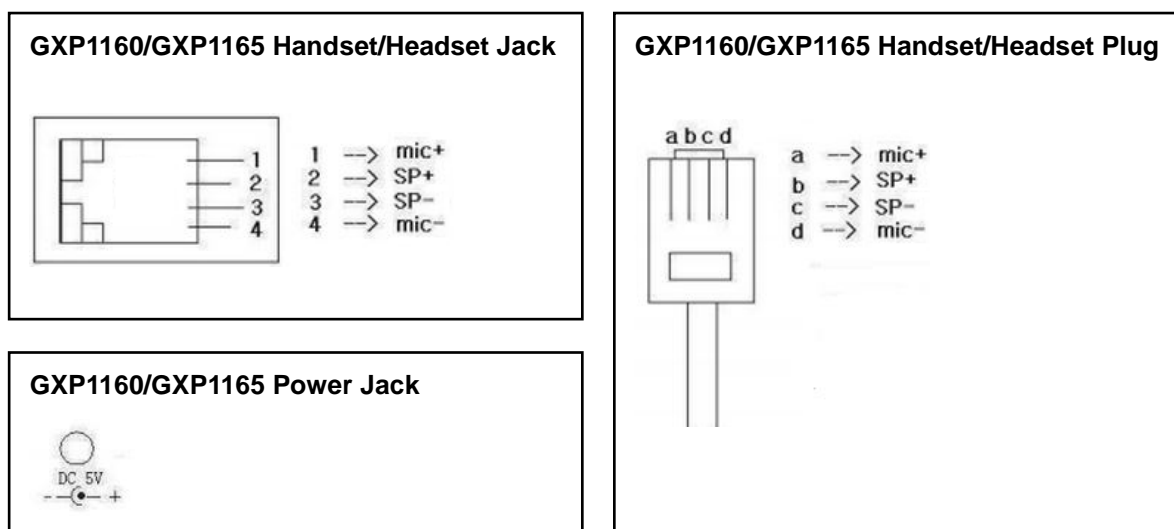

Figure 2: GXP1160/GXP1165 Pin-out

SAFETY COMPLIANCES

The GXP1160/GXP1165 phone complies with FCC/CE and various safety standards. The GXP1160/GXP1165 power adapter is compliant with the UL standard. Use the universal power adapter provided with the GXP1160/GXP1165 package only. The manufacturer's warranty does not cover damages to the phone caused by unsupported power adapters.

WARRANTY

If the GXP1160/GXP1165 phone was purchased from a reseller, please contact the company where the phone was purchased for replacement, repair or refund. If the phone was purchased directly from Grandstream, contact the Grandstream Support for a RMA (Return Materials Authorization) number before the product is returned. Grandstream reserves the right to remedy warranty policy without prior notification.

Warning:

Use the power adapter provided with the phone. Do not use a different power adapter as this may damage the phone. This type of damage is not covered under warranty.

USING THE GXP1160/GXP1165

GETTING FAMILAR WITH THE LCD



GXP1160/GXP1165 has a dynamic and customizable screen. The screen displays differently depending on whether the phone is idle or in use (active). The following table describes the items displayed on the GXP1160/GXP1165 idle screen.





Table 4: LCD DISPLAY DEFINITIONS

DATE AND TIME	Displays the current date and time. It can be synchronized with Internet time servers.
LOGO NAME	Displays company logo name. This logo name can be customized via xml screen customization. The maximum size for logo name string is 26 characters in English (approximately).
NETWORK STATUS	Shows the status of network in the middle of the screen. It will indicate whether the network is down or starting.
STATUS BAR	Shows the status of the phone for registration status, call features and etc, using icons as shown in the next table.
SOFTKEYS in Idle Screen	<p>The softkeys are context sensitive and will change depending on the status of the phone. Typical functions assigned to softkeys are:</p> <ul style="list-style-type: none"> • NextScr Toggles among default idle screen, weather information, IP Address and extension number. • Headset Onhook/offhook using headset; or toggle to headset mode. • FwdAll Unconditionally forwards the phone line (account 1) to another phone. • Missed Shows up unanswered calls to this phone. • Redial Redials the last dialed number when there is existed dialed call log.
SOFTKEYS in Call Screen	The softkeys are context sensitive and will change depending on the call status of the phone. Here are the main softkeys in call screen.

	<ul style="list-style-type: none"> • Redial Redials the last dialed number after off hook when there is existed call log. • Dial Dials the call out after off hook and entering the number. • Answer Answers the incoming call when the phone is ringing. • Reject Rejects the incoming call when the phone is ringing. • EndCall Ends the active call. • Headset Onhook/offhook using headset; or toggle to headset mode. • Mute Mute/Unmute in the current active call. • Transfer Transfer softkey will show up after pressing TRAN button and entering transfer target number. Press Transfer softkey to do blind transfer. • Split In auto-attended transfer mode, after establishing the second call, press Split to quit transfer and go back to normal talking status. • ConfCall Conferences the active calls. • ReConf Re-establish the conference among the calls on hold.
--	---

Table 5: GXP1160/GXP1165 LCD ICONS







	Registration Status: Registered.
	Registration Status: Not Registered.
	Handset Status. OFF - handset on hook ON - handset off hook
	Speaker Status. OFF - speaker off ON - speaker on
	Headset Status.



	OFF - headset off ON - headset on
	DND Status. OFF - Do Not Disturb disabled ON - Do Not Disturb enabled
	Call Forward Status. OFF - Call Forward feature disabled ON - Call Forward feature enabled
	MUTE Status. OFF - The active call is not muted ON - The active call is muted
	SRTP Status. OFF - SRTP is not used ON - SRTP is used

GETTING FAMILAR WITH THE KEYPAD

The following table describes the buttons used on the GXP1160/GXP1165 keypad.

Table 6: KEYPAD DEFINITIONS

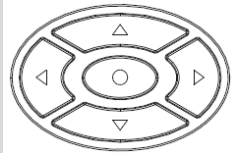
	Place active call on hold, or resume the call on hold.
	Transfer an active call to another number.
	Establish 3-way conference call with other 2 parties.
	Bring up a new line; or answer the second incoming call.
	Speaker.
	Send out the number, or redial.
	Phonebook. Brings phonebook on screen.

	Voicemail. Press to retrieve voice mails.
	Navigation Keys/Menu. <ul style="list-style-type: none"> • Press the 4 navigation keys to move up/down/left/right; • Press the round button in the center to enter Keypad Configuration MENU when phone is in idle; • The round button "MENU" can also be used as ENTER key when in Keypad Configuration.
	Volume. Press "-" or "+" to adjust the volume.
0 - 9, *, #	Standard phone keypad.

MAKING PHONE CALLS



HANDSET, SPEAKER AND HEADSET MODE

The GXP1160/GXP1165 allows users to switch among handset, speaker or headset when making calls. Press the Hook Switch to switch to handset; press the Headset softkey to switch to headset; or press the

Speaker button  to switch to speaker.

2 CALLS WITH 1 SIP ACCOUNT

GXP1160/GXP1165 can support up to two lines "virtually" mapped to one SIP account. By picking up the handset, the GXP1160/GXP1165 will be in off hook state and the dial tone will be heard. To make a call, dial out the number with the current line.

During the call, users can press the FLASH key  to hold the current call and make/answer another call. If they are 2 calls established, users can switch the two lines by pressing the FLASH key .

COMPLETING CALLS

There are several ways to complete a call on GXP1160/GXP1165.

- **On hook dialing.** Enter the number when the phone is on hook and then send out.
 - When the phone is in idle, enter the number to be dialed out;
 - Take handset off hook; or
Press Speaker button; or
Press Headset softkey with headset plugged in;
 - The call will be dialed out.

- **Off hook and dial.** Off hook the phone, enter the number and send out.
 - Take handset off hook; or
Press Speaker button; or
Press Headset softkey with headset plugged in;
 - You shall hear dial tone after off hook;
 - Enter the number;
 - Press SEND key  or # to dial out.

- **Redial.** Redial the last dialed number.
 - Take handset off hook; or
Press Speaker button; or
Press Headset softkey with headset plugged in; or
When the phone is in idle;
 - Press SEND key , or the REDIAL softkey.

- **Via Call History.** Dial the number logged in phone's call history.
 - Press MENU button to bring up the main menu;
 - Enter Call History and select "Answered Calls", "Missed Calls" or "Transferred Calls";
 - Select the entry you would like to call using the navigation "UP" and "DOWN" arrow keys;
 - Press SEND key  to dial out.

- **Via Phonebook.** Dial the number from the phonebook.
 - Press  key to bring up Phonebook; or
Press MENU button to bring up the main menu and select Phonebook to enter;
 - Select the phonebook entry you would like to call using the navigation "UP" and "DOWN" arrow keys;

- Press SEND key  to dial the selected contact.

- **Via Paging/Intercom.**
 - Take handset off hook; or
Press Speaker button; or
Press Headset softkey with headset plugged in;
 - You shall hear dial tone after off hook;
 - Press MENU button to switch the call screen from "DIAL" to "Paging";
 - Enter the number;
 - Press SEND key  or # to dial out.

Note:

- After entering the number, the phone waits for the No Key Entry Timeout (Default timeout is 4 seconds, configurable via Web GUI) before dialing out. Press SEND key  or # key to override the No Key Entry Timeout;

- If digits have been entered after handset is off hook, the SEND key  will work as SEND instead of REDIAL;

- By default, # can be used as SEND to dial the number out. Users could disable it by setting "User # as Dial Key" to "No" from Web GUI->Account->Call Settings;

- For Paging/Intercom, if the SIP Server/PBX supports the feature and has Paging/Intercom feature code set up already, users do not necessarily need to toggle to paging mode in the call screen. Simply dial the feature code with extension as a normal call.

- When dial out via paging, user can see the "call-info" header contains "answer-after=0" and the "alert-info" header contains "info=alert-autoanswer;delay=0" in the outgoing INVITE.

MAKING CALLS USING IP ADDRESSES

Direct IP Call allows two phones to talk to each other in an ad-hoc fashion without a SIP proxy. VoIP calls can be made between two phones if:

- Both phones have public IP addresses; or
- Both phones are on the same LAN/VPN using private or public IP addresses; or

- Both phones can be connected through a router using public or private IP addresses (with necessary port forwarding or DMZ).

To make a direct IP call, please follow the steps below:

- Press MENU button to bring up main menu;
- Select "Direct IP Call" using the navigation arrow keys;
- Press MENU to enter the Direct IP Call mode;
- Input the 12-digit target IP address (Please see example below);
- Press the "More" softkey to make sure the softkey selection "IPv4" or "IPv6" is correctly selected depending on your network environment;
- Press "OK" softkey to dial.

For example:

If the target IP address is 192.168.1.60 and the port is 5062 (i.e., 192.168.1.60:5062), input the following: 192*168*1*60#5062. The * key represents the dot (.), the # key represents colon (:). Wait for about 4 seconds and the phone will initiate the call.

Quick IP Call Mode:

The GXP1160/GXP1165 also supports Quick IP Call mode. This enables the phone to make direct IP calls using only the last few digits (last octet) of the target phone's IP address. This is possible only if both phones are under the same LAN/VPN. This simulates a PBX function using the CSMA/CD without a SIP server. Controlled static IP usage is recommended.

To enable Quick IP Call Mode, go to phone's Web GUI->Settings->Call Features, set "Use Quick IP Call Mode" to "Yes". Click on "Save and Apply" on the bottom of the Web GUI page to take the change. To make Quick IP Call, take the phone off hook first. Then dial #xxx where x is 0-9 and xxx<255. Press # or SEND and a direct IP call to aaa.bbb.ccc.XXX will be completed. "aaa.bbb.ccc" is from the local IP address regardless of subnet mask. The number #xx or #x are also valid. The leading 0 is not required (but it's OK).

For example:

- 192.168.0.2 calling 192.168.0.3 -- dial #3 followed by # or SEND key;
- 192.168.0.2 calling 192.168.0.23 -- dial #23 followed by # SEND key;
- 192.168.0.2 calling 192.168.0.123 -- dial #123 followed by # SEND key;
- 192.168.0.2: dial #3 and #03 and #003 results in the same call -- call 192.168.0.3.

Note:

- The # will represent colon ":" in direct IP call rather than SEND key as in normal phone call;

- If you have a SIP server configured, direct IP call still works. If you are using STUN, direct IP call will also use STUN;
- Configure the "User Random Port" to "No" when completing direct IP calls.

ANSWERING PHONE CALLS

RECEIVING CALLS

- **Single incoming call.** Phone rings with selected ring tone. Answer call by taking handset off hook, or using Speaker/Headset;
- **Multiple incoming calls.** When another call comes in while having an active call, the phone will produce a Call Waiting tone (stutter tone). Answer the incoming call by pressing the FLASH key



. The current active call will be put on hold automatically.

DO NOT DISTURB



Do Not Disturb can be enabled/disabled from phone's LCD MENU->Preference.

- Press the Menu button and select "Preference" using navigation keys;
- Press Menu button again to get into Preference options;
- Select "Do Not Disturb" and press Menu button;
- Use arrow keys "UP" and "DOWN" to select and press Menu button to enable or disable "Do Not Disturb" feature.

When Do Not Disturb feature is turned on, the DND icon will appear on the right side of the LCD. The incoming call will not be accepted or the call will directly go into voicemail.

DURING A PHONE CALL

CALL WAITING/CALL HOLD

- **Hold.** Place a call on hold by pressing the HOLD key  ;
- **Resume.** Resume call by pressing the HOLD key  ;
- **Multiple calls.** Automatically place active call on hold or switch between calls by pressing the FLASH

key  . Call waiting tone (stutter tone) will be audible on new incoming call during the active call.



MUTE

During an active call, press the MUTE softkey to mute/unmute the microphone. The LCD will show "Talking" or "MUTE" to indicate the mute status, with Mute icon displayed on the right side of the screen.



CALL TRANSFER

GXP1160/GXP1165 supports Blind Transfer, Attended Transfer and Auto-Attended Transfer.

- **Blind Transfer.**

- During the first active call, press TRAN key  and dial the number to transfer to;
- Press SEND key  or # to complete transfer of active call.



- **Attended Transfer.**

- During the first active call, press FLASH key  . The first call will be put on hold;
- Enter the number for the second call in the new line and establish the call;
- Press TRAN key  ;
- Press FLASH key  to transfer the call.

- **Auto-Attended Transfer.**

- Set "Auto-Attended Transfer" to "Yes" under Web GUI->Settings->Call Features. And then click "Save and Apply" on the bottom of the page;
- Establish one call first;
- During the call, press TRAN key  . A new line will be brought up and the first call will be

automatically placed on hold;

- Dial the number and press SEND key  or # to make a second call. (Once the number is entered, a "Transfer" softkey will show. If "Transfer" softkey is pressed instead of SEND or #, a blind transfer will be performed);
- Press TRAN key  again. The call will be transferred.
- For Auto-Attended Transfer, after dialing out the number for the second call, a "Split" softkey will show. If the second call is not established yet (ringing), pressing "Split" will hang up the second call. If the second call is established (answered), pressing "Split" will resume the second call and keep the first call on hold.



Note:

- To transfer calls across SIP domains, SIP service providers must support transfer across SIP domains.
- When two lines are active, GXP116x can only do attended transfer because the phone supports at most two lines simultaneously.

3-WAY CONFERENCING

GXP1160/GXP1165 can host 3-way conference call with another 2 parties (PCMU/PCMA).



- **Initiate a conference call.**

- Establish calls with 2 parties respectively;
- Press CONF key ;
- Press FLASH key . The 3-way conference will be established.

- **Cancel Conference.**

- The user can press the "Cancel" softkey to cancel a conference after pressed CONF key .
- This will resume the 2-way conversation with the current line.

- **Split and Re-conference.**



- During the conference, press HOLD key. The conference call will be split and the calls will be put on hold separately;
- Press FLASH key  to resume the 2-way conversation with the second established call;
- If users would like to re-establish conference call, before FLASH key  is pressed in the above step, press the ReConf softkey right after the conference call is held/split;

- **End Conference.**



- Press HOLD key  to split the conference call. The conference call will be ended with both calls on hold; Or
- Users could press the EndCall softkey or simply hang up the call to terminate the conference call.

GXP1160/GXP1165 supports **Easy Conference Mode**, which can be used combined with the traditional way to establish the conference.

- **Initiate a conference call.**

- Establish 1 call;
- Press CONF key  and a new line will be brought up;
- Dial the number and press SEND key  to establish the second call;
- Press CONF key  or press the ConfCall softkey to establish the conference.

- **Split and Re-conference.**

- During the conference, press HOLD key . The conference call will be split and both calls will be put on hold separately;
- Press FLASH key  to resume the 2-way conversation with the second established call;
- If users would like to re-establish conference call, press the ReConf softkey.

- **Cancel Conference.**

- If users decides not to conference after establishing the second call, press EndCall softkey;
- This will end the second call and the screen will show the first call on hold.

- **End Conference.**

- Press HOLD key  to split the conference call. The conference call will be ended with both calls on hold; Or
- Users could press the EndCall softkey or simply hang up the call to terminate the conference call.

Note:

- The party that starts the conference call has to remain in the conference for its entire duration, you can put the party on mute but it must remain in the conversation. Also, this is not applicable when the feature "Transfer on Conference Hangup" is turned on.
- The option "Disable Conference" has to be set to "No" to establish conference.
- When using **Easy Conference Mode**, use SEND key  to dial out the second call instead of using #, even when # could be used as SEND in normal phone calls.

VOICE MESSAGES (MESSAGE WAITING INDICATOR)

A blinking red MWI (Message Waiting Indicator) indicates a message is waiting. Dial into the voicemail box to retrieve the message by entering the voice mail number of the server or pressing the MESSAGE key



(Voice Mail User ID has to be properly configured as the voice mail number under Web GUI->Account x->General Settings). An IVR will prompt the user through the process of message retrieval.

Note: When the feature "Blink message LED on ringing" is enabled, the message LED will blink for both incoming call and new messages in mailbox.

CALL FEATURES

The GXP1160/GXP1165 supports traditional and advanced telephony features including caller ID, caller ID with caller Name, call forward and etc.

Table 7: CALL FEATURES

*30	<p>Block Caller ID (for all subsequent calls)</p> <ul style="list-style-type: none"> • Off hook the phone; • Dial *30.
*31	<p>Send Caller ID (for all subsequent calls)</p> <ul style="list-style-type: none"> • Off hook the phone; • Dial *31.
*67	<p>Block Caller ID (per call)</p> <ul style="list-style-type: none"> • Off hook the phone; • Dial *67 and then enter the number to dial out.
*82	<p>Send Caller ID (per call)</p> <ul style="list-style-type: none"> • Off hook the phone; • Dial *82 and then enter the number to dial out.
*70	<p>Disable Call Waiting (per Call)</p> <ul style="list-style-type: none"> • Off hook the phone; • Dial *70 and then enter the number to dial out.
*71	<p>Enable Call Waiting (per Call)</p> <ul style="list-style-type: none"> • Off hook the phone; • Dial *71 and then enter the number to dial out.
*72	<p>Unconditional Call Forward. To set up unconditional call forward:</p> <ul style="list-style-type: none"> • Off hook the phone; • Dial *72 and then enter the number to forward the call; • Press OK softkey or SEND key.
*73	<p>Cancel Unconditional Call Forward. To cancel the unconditional call forward:</p> <ul style="list-style-type: none"> • Off hook the phone; • Dial *73; • Hang up the call.
*90	<p>Busy Call Forward. To set up busy call forward:</p> <ul style="list-style-type: none"> • Off hook the phone; • Dial *90 and then enter the number to forward the call; • Press OK softkey or SEND key.

*91	Cancel Busy Call Forward. To cancel the busy call forward: <ul style="list-style-type: none">• Off hook the phone;• Dial *91;• Hang up the call.
*92	Delayed Call Forward. To set up delayed call forward: <ul style="list-style-type: none">• Off hook the phone;• Dial *92 and then enter the number to forward the call;• Press OK softkey or SEND key.
*93	Cancel Delayed Call Forward. To cancel the delayed call forward: <ul style="list-style-type: none">• Off hook the phone;• Dial *93;• Hang up the call.

CUSTOMIZED LCD SCREEN & XML

The GXP1160/GXP1165 IP phone supports the following XML applications. Please refer to the corresponding link for documentation and templates.

- XML custom idle screen (customize idle screen logo, softkey layout, and etc.)

http://www.grandstream.com/products/gxp_series/general/documents/GXP2120/GXP2110/GXP2100_14xx_XML_Screen_Customization.zip

- XML downloadable phonebook

http://www.grandstream.com/products/gxp_series/general/documents/gxp_wp_xml_phonebook.pdf

CONFIGURATION GUIDE

The GXP1160/GXP1165 can be configured via two ways:

- LCD Configuration Menu using the phone's keypad;
- Web GUI embedded on the phone using PC's web browser.

CONFIGURATION VIA KEYPAD

To configure the LCD menu using phone's keypad, follow the instructions below:

- **Enter MENU options.** When the phone is in idle, press the round MENU button to enter the configuration menu;
- **Navigate in the menu options.** Press the arrow keys UP/DOWN/LEFT/RIGHT to navigate in the menu options;
- **Enter/Confirm selection.** Press the round MENU button to enter the selected option;
- **Exit.** Press LEFT arrow key to exit to the previous menu;
- The phone automatically exits MENU mode with an incoming call, when the phone is off hook or the MENU mode if left idle for more than 60 seconds.
- When the phone is in idle, pressing the navigation keys UP/DOWN/RIGHT can access the call history entries:
 - UP - Missed Calls
 - DOWN - Dialed Calls
 - RIGHT - Answered Calls

The MENU options are listed in the following table.

Table 8: CONFIGURATION MENU

Call History	Displays call logs for answered calls, dialed calls, missed calls and transferred calls.
Status	<p>Displays network status, account registration status, software version number, MAC address, hardware version number, P/N number.</p> <ul style="list-style-type: none"> • Network status <p>Press to enter the sub menu for IP setting information (DHCP/Static IP/PPPoE), IPv4 address, IPv6 address, MAC address, Subnet Mask,</p>

	<p>Gateway and DNS server.</p> <ul style="list-style-type: none"> • Account X: Registered/Not Registered. • Boot version • Prog version: This is the main firmware release number. • Core version • Base version • Aux version • DSP version • MAC address • HW version • P/N number • Power Source
Phone Book	<p>Displays phonebook. Users could add, edit, search and delete contacts/groups here, or download phonebook XML to the phone. Phonebook search does not support entering Non-ASCII characters.</p> <p>Note: Besides 3 embedded groups: Family, Friends and Work, user can create your own new groups. GXP phone allows at most 7 customized groups.</p>
LDAP Directory	<p>Searches LDAP directory and configures LDAP options. LDAP search does not support entering Non-ASCII characters</p>
Instant Messages	<p>Displays received instant messages.</p>
Direct IP Call	<p>Makes direct IP call.</p>
Preference	<p>Preference sub menu includes the following options:</p> <ul style="list-style-type: none"> • Do Not Disturb Enables/disables Do Not Disturb on the phone. • Ring Tone Configures different ring tones for incoming call. • Ring Volume Adjusts ring volume by pressing left/right arrow key. • LCD Contrast Adjusts LCD contrast by pressing left/right arrow key. • Download SCR XML Triggers the phone to download the XML idle screen file immediately. The XML

	<p>idle screen server path and downloading method need to be set up correctly from Web GUI first.</p> <ul style="list-style-type: none"> • Erase Custom SCR Erases custom XML idle screen previously loaded on the phone. After erasing it, the phone will show default idle screen. • Display Language Selects the language to be displayed on the phone's LCD. Users could select Automatic for local language based on IP location if available. • Time Settings Configures date and time on the phone. • Star Key Lock Turns on/off keypad lock feature and configures keypad lock password.
<p>Config</p>	<p>Config sub menu includes the following options:</p> <ul style="list-style-type: none"> • SIP Configures SIP Proxy, Outbound Proxy, SIP User ID, SIP Auth ID, SIP Password, SIP Transport and Audio information to register SIP account on the phone. • Upgrade Configures firmware server and config server for upgrading and provisioning the phone. • Factory Reset Resets the phone to factory default settings. • Layer 2 QoS Configures 802.1Q/VLAN Tag and priority value. • Headset Type Selects the headset type "Normal" or "Plantronics EHS" used on the phone.
<p>Factory Functions</p>	<p>Factory Functions sub menu includes the following options:</p> <ul style="list-style-type: none"> • Audio Loopback Speak to the phone using speaker/handset/headset. If you can hear your voice, your audio is working fine. Press Menu button to exit audio loopback mode. • Diagnostic Mode All LEDs will light up. Press any key (except MENU key) on the keypad to display the button name in the LCD. Lift and put back the handset or press Menu button to exit diagnostic mode.

	<ul style="list-style-type: none"> • Keyboard Diagnostic Press all the available keys on the phone. The LCD will display the name for the keys to be pressed to finish the keyboard diagnostic mode.
Network	Selects IP mode (DHCP/Static IP/PPPoE); Configures PPPoE account ID and password; Configures IP address, Netmask, Gateway, DNS Server 1 and DNS Server 2; Configures 802.1X mode.
Call Features	Configures call forward features for Forward All, Forward Busy, Forward No Answer and No Answer Timeout.
Voice Mails	Displays voicemail message information in the format below: new messages/all messages (urgent messages/all urgent messages)
UCM Connection	<ul style="list-style-type: none"> • UCM Server List Displays connected UCM server List. • Input Server IP Manually Specifies Protocol, IP and Port of the target UCM server
Reboot	Reboot the phone.
Exit	Exit from this menu.

The following picture shows the keypad MENU configuration flow.

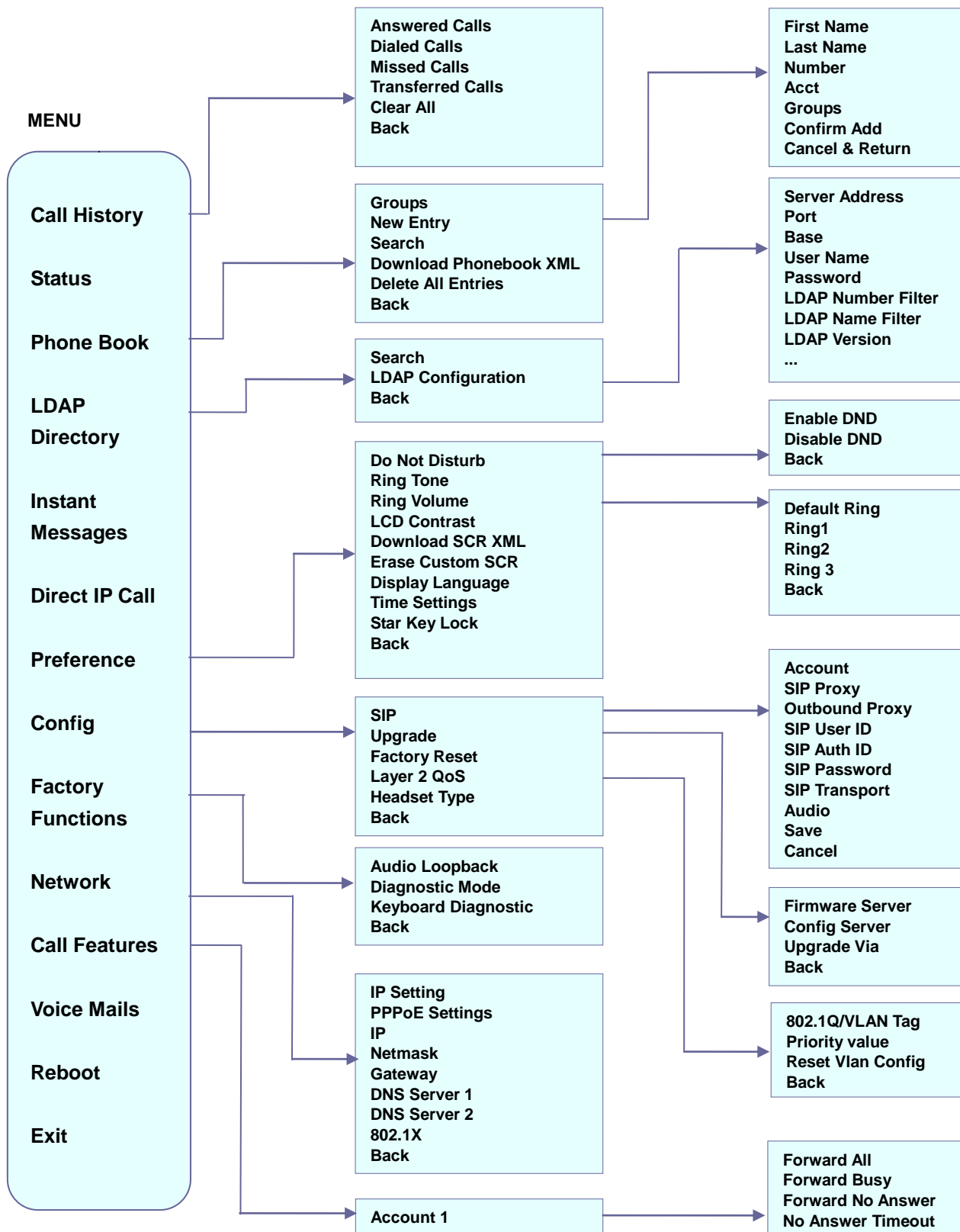

Figure 3: Keypad MENU Flow

CONFIGURATION VIA WEB BROWSER

The GXP1160/GXP1165 embedded Web server responds to HTTP/HTTPS GET/POST requests. Embedded HTML pages allow a user to configure the IP phone through a Web browser such as Microsoft's IE, Mozilla Firefox and Google Chrome.

To access the Web GUI:

1. Connect the computer to the same network as the phone;
2. Make sure the phone is turned on and shows its IP address. You may check the IP address on the LCD by pressing NextScr softkey or go to MENU->Status->Network Status;
3. Open a Web browser on your computer;
4. Enter the phone's IP address in the address bar of the browser;
5. Enter the administrator's login and password to access the Web Configuration Menu.

Note:

- The computer has to be connected to the same sub-network as the phone. This can be easily done by connecting the computer to the same hub or switch as the phone connected to. In absence of a hub/switch (or free ports on the hub/switch), please connect the computer directly to the PC port on the back of the phone;
- If the phone is properly connected to a working Internet connection, the IP address of the phone will display in MENU->Status->Network Status. This address has the format: xxx.xxx.xxx.xxx, where xxx stands for a number from 0-255. Users will need this number to access the Web GUI. For example, if the phone has IP address 192.168.40.154, please enter "http://192.168.40.154" in the address bar of the browser;
- There are two default passwords for the login page:

User Level	Password	Web Pages Allowed
End User Level	123	Only Status and Basic Settings
Administrator Level	admin	Browse all pages

The password is case sensitive with maximum length of 25 characters.

- When changing any settings, always SUBMIT them by pressing the "Save" or "Save and Apply" button on the bottom of the page. If the change is saved only but not applied, after making all the changes, click on the "APPLY" button on top of the page to submit. After submitting the changes in all the Web GUI pages, reboot the phone to have the changes take effect if necessary (All the options under "Accounts" page and "Phonebook" page do not require reboot. Most of the options under "Settings" page do not require reboot).

DEFINITIONS

This section describes the options in the phone's Web GUI. As mentioned, you can log in as an administrator or an end user.

- **Status:** Displays the Account status, Network status, and System Info of the phone;
- **Account:** To configure the SIP account;
- **Network:** To configure network settings;
- **Settings:** To configure call features, ring tone, LCD display, Web services, XML applications and etc;
- **Maintenance:** To configure web/Telnet access, upgrading and provisioning, language settings, TR-069, security and etc.
- **Phonebook:** To manage Phonebook and LDAP.

STATUS PAGE DEFINITIONS

Status -> Account Status

SIP User ID	Displays the configured SIP User ID.
SIP Server	Displays the configured SIP Server address.
SIP Registration	Displays SIP registration status YES/NO.

Status -> Network Status

MAC Address	Global unique ID of device, in HEX format. The MAC address will be used for provisioning and can be found on the label coming with original box and on the label located on the back of the device.
IP Setting	DHCP, Static IP or PPPoE.
IPv4 Address	The IPv4 address obtained on the phone.
IPv6 Address	The IPv6 address obtained on the phone.
Subnet Mask	The subnet mask obtained on the phone.
Gateway	The gateway address obtained on the phone.
DNS Server 1	The DNS server address 1.
DNS Server 2	The DNS server address 2.
NTP Server	The NTP server phone uses to sync up time.
PPPoE Link Up	PPPoE connection status.
802.1q/802.1p(LLDP)	The 802.1q/802.p status.
802.1q/VLAN Tag	The assigned VLAN tag on phone.

802.1q Priority	The assigned 802.1q priority on phone.
NAT Traversal	NAT traversal status for the account.
Status -> System Info	
Product Model	Product model of the phone.
Part Number	Product part number.
Software Version	<ul style="list-style-type: none"> • Boot: boot version number; • Core: core version number; • Base: base version number; • Prog: program version number. This is the main firmware release number, which is always used for identifying the software system of the phone; • Aux: Aux version number; • Dsp: DSP version number.
System Up Time	System up time since the last reboot.
System Time	Current system time on the phone system.
Service Status	GUI and Phone service status.
Core Dump	Core dump file that could be downloaded for troubleshooting purpose.

ACCOUNTS PAGE DEFINITIONS

Account x -> General Settings	
Account Active	Activates/deactivates account. The default setting is "Yes".
Account Name	The name associated with the SIP account.
SIP Server	The URL or IP address, and port of the SIP server. This is provided by your VoIP service provider (ITSP).
Secondary SIP Server	The URL or IP address, and port of the SIP server. This will be used when the primary SIP server fails.
Outbound Proxy	IP address or Domain name of the Primary Outbound Proxy, Media Gateway, or Session Border Controller. It's used by the phone for Firewall or NAT penetration in different network environments. If a symmetric NAT is detected, STUN will not work and ONLY an Outbound Proxy can provide a solution.
SIP User ID	User account information, provided by your VoIP service provider (ITSP). It's usually in the form of digits similar to phone number or actually a phone number.
Authenticate ID	SIP service subscriber's Authenticate ID used for authentication. It can be identical to or different from the SIP User ID.
Authenticate Password	The account password required for the phone to authenticate with the ITSP

	(SIP) server before the account can be registered. After it is saved, this will appear as hidden for security purpose.
Name	The SIP server subscriber's name (optional) that will be used for Caller ID display.
Voice Mail User ID	Allows you to access voice messages by pressing the MESSAGE button on the phone. This ID is usually the VM portal access number. For example, in Asterisk server, 8500 could be used.

Account x -> Network Settings

DNS Mode	<p>This parameter controls how the Search Appliance looks up IP addresses for hostnames. There are four modes: A Record, SRV, NATPTR/SRV, Use Configured IP. The default setting is "A Record". If the user wishes to locate the server by DNS SRV, the user may select "SRV" or "NATPTR/SRV". If "Use Configured IP" is selected, please fill in the three fields below:</p> <ul style="list-style-type: none"> • Primary IP: The primary IP address where the phone sends DNS query to; • Backup IP 1; • Backup IP 2. <p>If SIP server is configured as domain name, phone will not send DNS query, but use "Primary IP" or "Backup IP x" to send SIP message if at least one of them are not empty. Phone will try to use "Primary IP" first. After 3 tries without any response, it will switch to "Backup IP x", and then it will switch back to "Primary IP" after 3 re-tries.</p> <p>If SIP server is already an IP address, phone will use it directly even "User Configured IP" is selected.</p>
NAT Traversal	<p>This parameter configures whether the NAT traversal mechanism is activated. Users could select the mechanism from No, STUN, Keep-Alive, UPnP, Auto or VPN. If set to "STUN" and STUN server is configured, the phone will route according to the STUN server. If NAT type is Full Cone, Restricted Cone or Port-Restricted Cone, the phone will try to use public IP addresses and port number in all the SIP&SDP messages. The phone will send empty SDP packet to the SIP server periodically to keep the NAT port open if it is configured to be "Keep-Alive". Configure this to be "No" if an outbound proxy is used. "STUN" cannot be used if the detected NAT is symmetric NAT.</p>
Proxy-Require	<p>A SIP Extension to notify the SIP server that the phone is behind a NAT/Firewall. Do not configure this parameter unless this feature is supported on the SIP server.</p>

Account x -> SIP Settings -> Basic Settings

TEL URI	If the phone has an assigned PSTN telephone number, this field should be set
---------	--

	to "User=Phone". Then a "User=Phone" parameter will be attached to the Request-Line and "TO" header in the SIP request to indicate the E.164 number. If set to "Enable", "Tel:" will be used instead of "SIP:" in the SIP request. The default setting is "Disable".
SIP Registration	Selects whether or not the phone will send SIP Register messages to the proxy/server. The default setting is "Yes".
Unregister On Reboot	If set to "Yes", the SIP user's registration information will be cleared when the phone reboots. The SIP Contact header will contain "*" to notify the server to unbind the connection. The default setting is "No".
Register Expiration	Specifies the frequency (in minutes) in which the phone refreshes its registration with the specified registrar. The default value is 60 minutes. The maximum value is 64800 minutes (about 45 days).
Reregister Before Expiration	Specifies the time frequency (in seconds) that the phone sends re-registration request before the Register Expiration. The default value is 0.
Local SIP Port	Defines the local SIP port used to listen and transmit. The default value is 5060 for Account 1.
SIP Registration Failure Retry Wait Time	Specifies the interval to retry registration if the process is failed. The default value is 20 seconds.
SIP T1 Timeout	SIP T1 Timeout. The default setting is 0.5 seconds.
SIP T2 interval	SIP T2 Interval. The default setting is 4 seconds.
SIP Transport	Determines the network protocol used for the SIP transport. Users can choose from TCP, UDP and TLS.
SIP URI Scheme when using TLS	Specifies if "sip:" or "sips:" will be used when TLS/TCP is selected for SIP Transport. The default setting is "sips:".
Use Actual Ephemeral Port in Contact with TCP/TLS	This option is used to control the port information in the Via header and Contact header. If set to No, these port numbers will use the permanent listening port on the phone. Otherwise, they will use the ephemeral port for the particular connection.
Remove OBP from route	Configures to remove outbound proxy from route. This is used for the SIP Extension to notify the SIP server that the device is behind a NAT/Firewall.
Support SIP Instance ID	Defines whether SIP Instance ID is supported or not. The default setting is "Yes".
SUBSCRIBE for MWI	When set to "Yes", a SUBSCRIBE for Message Waiting Indication will be sent periodically. The phone supports synchronized and non-synchronized MWI. The default setting is "No".
SUBSCRIBE for Registration	When set to "Yes", a SUBSCRIBE for Registration will be sent out periodically. The default setting is "No".

Enable 100rel	The use of the PRACK (Provisional Acknowledgment) method enables reliability to SIP provisional responses (1xx series). This is very important in order to support PSTN interworking. To invoke a reliable provisional response, the 100rel tag is appended to the value of the required header of the initial signaling messages.
Caller ID Display	When set to "Auto", the phone will look for the caller ID in the order of P-Asserted Identity Header, Remote-Party-ID Header and From Header in the incoming SIP INVITE. When set to "Disabled", all incoming calls are displayed with "Unavailable". When set to "From Header", the phone will display the caller ID based on the From Header in the incoming SIP INVITE. The default setting is "Auto".
Use Privacy Header	Controls whether the Privacy Header will present in the SIP INVITE message or not. The default setting is "default": the Privacy Header will show in INVITE unless "Huawei IMS" special feature is on. If set to "Yes", the Privacy Header will always show in INVITE. If set to "No", the Privacy Header will not show in INVITE.
Use P-Preferred-Identity Header	Controls whether the P-Preferred-Identity Header will present in the SIP INVITE message or not. The default setting is "default": the P-Preferred-Identity Header will show in INVITE unless "Huawei IMS" special feature is on. If set to "Yes", the P-Preferred-Identity Header will always show in INVITE. If set to "No", the P-Preferred-Identity Header will not show in INVITE.
Account x -> SIP Settings -> Advanced Features	
Broadsoft Call Center	Default setting is "No". When set to "Yes", a soft key "BSCCenter" is displayed on LCD. User can access different Broadsoft Call Center agent features via this soft key. Please note that "Feature Key Synchronization" will be enabled regardless of this setting.
Hoteling Event	Broadsoft Hoteling event feature. Default setting is "No". With "Hoteling Event" enabled, user can access the Hoteling feature option by pressing the "BSCCenter" soft key.
Call Center Status	When set to "Yes", the phone will send SUBSCRIBE to the server to obtain call center status. The default setting is "No".
Publish to Call Center	When set to "Yes", users could select "Away", "Online" or "Busy" from LCD menu and publish it to call center. The default setting is "No".
Feature Key Synchronization	This feature is used for Broadsoft call feature synchronization. When it's enabled, DND, Call Forward features and Call Center Agent status can be synchronized between Broadsoft server and phone. The default setting is "Disabled".

Conference URI	Configures the conference URI when using Broadsoft N-way calling feature.
Music On Hold URI	Configures Music On Hold URI to call when a call is on hold. This feature has to be supported on the server side.
Special Feature	Different soft switch vendors have special requirements. Therefore users may need select special features to meet these requirements. Users can choose from Standard, Nortel MCS, Broadsoft, CBCOM, RNK, Sylanro or Huawei IMS depending on the server type. The default setting is "Standard".

Account x -> SIP Settings -> Session Timer

Session Expiration	The SIP Session Timer extension that enables SIP sessions to be periodically "refreshed" via a SIP request (UPDATE, or re-INVITE). If there is no refresh via an UPDATE or re-INVITE message, the session will be terminated once the session interval expires. Session Expiration is the time (in seconds) where the session is considered timed out, provided no successful session refresh transaction occurs beforehand. The default value is 180 seconds.
Min-SE	The minimum session expiration (in seconds). The default value is 90 seconds.
Caller Request Timer	If set to "Yes" and the remote party supports session timers, the phone will use a session timer when it makes outbound calls.
Callee Request Timer	If set to "Yes" and the remote party supports session timers, the phone will use a session timer when it receives inbound calls.
Force Timer	If Force Timer is set to "Yes", the phone will use the session timer even if the remote party does not support this feature. If Force Timer is set to "No", the phone will enable the session timer only when the remote party supports this feature. To turn off the session timer, select "No".
UAC Specify Refresher	As a Caller, select UAC to use the phone as the refresher; or select UAS to use the Callee or proxy server as the refresher.
UAS Specify Refresher	As a Callee, select UAC to use caller or proxy server as the refresher; or select UAS to use the phone as the refresher.
Force INVITE	The Session Timer can be refreshed using the INVITE method or the UPDATE method. Select "Yes" to use the INVITE method to refresh the session timer.

Account x -> SIP Settings -> Security Settings

Check Domain Certificates	Choose whether the domain certificates will be checked or not when TLS/TCP is used for SIP Transport. The default setting is "No".
Validate Incoming Messages	Choose whether the incoming messages will be validated or not. The default setting is "No".
Check SIP User ID for incoming INVITE	If set to "Yes", SIP User ID will be checked in the Request URI of the incoming INVITE. If it doesn't match the phone's SIP User ID, the call will be rejected.

	The default setting is "No".
Accept Incoming SIP from Proxy Only	When set to "Yes", the SIP address of the Request URL in the incoming SIP message will be checked. If it doesn't match the SIP server address of the account, the call will be rejected. The default setting is "No".
Authenticate Incoming INVITE	If set to "Yes", the phone will challenge the incoming INVITE for authentication with SIP 401 Unauthorized response. The default setting is "No".
Account x -> Audio Settings	
Send DTMF	Specifies the mechanism to transmit DTMF digits. There are 3 supported modes: in audio which means DTMF is combined in the audio signal (not very reliable with low-bit-rate codecs), via RTP (RFC2833), or via SIP INFO.
DTMF Payload Type	Configures the payload type for DTMF using RFC2833. The default value is 101.
Preferred Vocoder	7 different vocoder types are supported on the phone, including G.711 U-law (PCMU), G.711 A-law (PCMA), G.723.1, G.729A/B, G.722 (wide band), iLBC and G726-32. Users can configure vocoders in a preference list that is included with the same preference order in SDP message.
Use First Matching Vocoder in 200OK SDP	When set to "Yes", the device will use the first matching vocoder in the received 200OK SDP as the codec. The default setting is "No".
SRTP Mode	Enables the SRTP mode based on your selection. The default setting is "Disabled".
Crypto Life Time	Choose whether to include the lifetime parameter in SRTP crypto offer.
Symmetric RTP	Defines whether symmetric RTP is supported or not. The default setting is "No".
Silence Suppression	Controls the silence suppression/VAD feature of the audio codec G.723 and G.729. If set to "Yes", when silence is detected, a small quantity of VAD packets (instead of audio packets) will be sent during the period of no talking. If set to "No", this feature is disabled. The default setting is "No".
Voice Frames Per TX	Configures the number of voice frames transmitted per packet. When configuring this, it should be noted that the "ptime" value for the SDP will change with different configurations here. This value is related to the codec used and the actual frames transmitted during the in payload call. For end users, it is recommended to use the default setting, as incorrect settings may influence the audio quality.
G723 Rate	Selects encoding rate for G723 codec. The default value is 5.3kbps.
G.726-32 Packing Mode	Selects "ITU" or "IETF" for G726-32 packing mode.
iLBC Frame Size	Selects iLBC packet frame size. The default value is 30ms.
iLBC Payload Type	Specifies iLBC Payload type. The default value is 97. The valid range is

	between 96 and 127.
Jitter Buffer Type	Selects either Fixed or Adaptive based on network conditions. The default setting is "Adaptive".
Jitter Buffer Length	Selects Low, Medium, or High based on network conditions. The default setting is "Medium".

Account x -> Call Settings

Early Dial	Selects whether or not to enable early dial. If it's set to "Yes", the SIP proxy must support 484 response. The default setting is "No".
Dial Plan Prefix	Sets the prefix added to each dialed number.

Dial Plan	<p>A dial plan establishes the expected number and pattern of digits for a telephone number. This parameter configures the allowed dial plan for the phone.</p> <p>Dial Plan Rules:</p> <ol style="list-style-type: none"> 1. Accepted Digits: 1,2,3,4,5,6,7,8,9,0 , *, #, A,a,B,b,C,c,D,d; 2. Grammar: x - any digit from 0-9; <ol style="list-style-type: none"> a) xx+ - at least 2 digit numbers b) xx. - only 2 digit numbers c) ^ - exclude d) [3-5] - any digit of 3, 4, or 5 e) [147] - any digit of 1, 4, or 7 f) <2=011> - replace digit 2 with 011 when dialing g) - the OR operand <ul style="list-style-type: none"> • Example 1: {[369]11 1617xxxxxxx} <p>Allow 311, 611, and 911 or any 10 digit numbers with leading digits 1617;</p> <ul style="list-style-type: none"> • Example 2: {^1900x+ <=1617>xxxxxxx} <p>Block any number of leading digits 1900 or add prefix 1617 for any dialed 7 digit numbers;</p> <ul style="list-style-type: none"> • Example 3: {1xxx[2-9]xxxxxx <2=011>x+} <p>Allows any number with leading digit 1 followed by a 3 digit number, followed by any number between 2 and 9, followed by any 7 digit number OR Allows any length of numbers with leading digit 2, replacing the 2 with 011 when dialed.</p> <p>Example of a simple dial plan used in a Home/Office in the US:</p>
-----------	--

	<p>{ ^1900x. <=1617>[2-9]xxxxxx 1[2-9]xx[2-9]xxxxxx 011[2-9]x. [3469]11 }</p> <p>Explanation of example rule (reading from left to right):</p> <ul style="list-style-type: none"> • ^1900x. - prevents dialing any number started with 1900; • <=1617>[2-9]xxxxxx - allows dialing to local area code (617) numbers by dialing 7 numbers and 1617 area code will be added automatically; • 1[2-9]xx[2-9]xxxxxx - allows dialing to any US/Canada Number with 11 digits length; • 011[2-9]x - allows international calls starting with 011; • [3469]11 - allows dialing special and emergency numbers 311, 411, 611 and 911. <p>Note:</p> <p>In some cases where the user wishes to dial strings such as *123 to activate voice mail or other applications provided by their service provider, the * should be predefined inside the dial plan feature. An example dial plan will be: { *x+ } which allows the user to dial * followed by any length of numbers.</p>
Delayed Call Forward Wait Time	Defines the timeout (in seconds) before the call is forwarded on no answer. The default value is 20 seconds.
Enable Call Features	The default setting is "Yes". When enabled, call features using star codes will be supported locally. If set to "No", Call Features and DND options under LCD menu are supported. And ForwardAll soft key will not be displayed in LCD for Account 1.
Call Log	Configures Call Log setting on the phone. You can log all calls, only log incoming/outgoing calls or disable call log. The default setting is "Log All Calls".
Account Ring Tone	Allows users to configure the ringtone for the account. Users can choose from different ringtones from the dropdown menu.
Matching Incoming Caller ID	<p>Specifies matching rules with number, pattern or Alert Info text. When the incoming caller ID or Alert Info matches the rule, the phone will ring with selected distinctive ringtone. Matching rules:</p> <ul style="list-style-type: none"> • Specific caller ID number. For example, 8321123; • A defined pattern with certain length using x and + to specify, where x could be any digit from 0 to 9. Samples: <ul style="list-style-type: none"> xx+ : at least 2-digit number; xx : only 2-digit number; [345]xx: 3-digit number with the leading digit of 3, 4 or 5; [6-9]xx: 3-digit number with the leading digit from 6 to 9. • Alert Info text

	<p>Users could configure the matching rule as certain text (e.g., priority) and select the custom ring tone mapped to it. The custom ring tone will be used if the phone receives SIP INVITE with Alert-Info header in the following format:</p> <p>Alert-Info: <http://127.0.0.1>; info=priority</p> <p>Selects the distinctive ring tone for the matching rule. When the incoming caller ID or Alert Info matches the rule, the phone will ring with the selected ring.</p>
Ring Timeout	Defines the timeout (in seconds) for the rings on no answer. The default setting is 60 seconds.
Send Anonymous	If set to "Yes", the "From" header in outgoing INVITE messages will be set to anonymous, essentially blocking the Caller ID to be displayed.
Anonymous Call Rejection	If set to "Yes", anonymous calls will be rejected. The default setting is "No".
Auto Answer	If set to "Yes", the phone will automatically turn on the speaker phone to answer incoming calls after a short reminding beep.
Allow Auto Answer by Call-Info	<p>If set to "Yes", the phone will automatically turn on the speaker phone to answer incoming calls after a short reminding beep, based on the SIP info header sent from the server/proxy. The default setting is "No".</p> <p>Phone will auto answer calls when the "call-info" header contains "answer-after=0" in the incoming INVITE</p>
Refer-To Use Target Contact	If set to "Yes", the "Refer-To" header uses the transferred target's Contact header information for attended transfer. The default setting is "No".
Transfer on Conference Hangup	Defines whether or not the call is transferred to the other party if the initiator of the conference hangs up. The default setting is "No".
No Key Entry Timeout (s)	Defines the timeout (in seconds) for no key entry. If no key is pressed after the timeout, the digits will be sent out. The default value is 4 seconds.
Use # as Dial Key	Allows users to configure the "#" key as the "Send" key. If set to "Yes", the "#" key will immediately dial out the input digits. In this case, this key is essentially equivalent to the "Send" key. If set to "No", the "#" key is included as part of the dialing string.
Hold Method	Specifies Hold method to Auto or RFC3264. Auto is to satisfy both rfc3264 and rfc2xxx for the maximum capability.

SETTINGS PAGE DEFINITIONS

Settings -> General Settings	
Local RTP Port	This parameter defines the local RTP port used to listen and transmit. It is the base RTP port for channel 0. When configured, channel 0 will use this port _value for RTP; channel 1 will use port_value+2 for RTP. Local RTP port ranges from 1024 to 65400 and must be even. The default value is 5004.
Use Random Port	When set to "Yes", this parameter will force random generation of both the local SIP and RTP ports. This is usually necessary when multiple phones are behind the same full cone NAT. The default setting is "Yes" (This parameter must be set to "No" for Direct IP Calling to work).
Keep-alive Interval	Specifies how often the phone sends a blank UDP packet to the SIP server in order to keep the "ping hole" on the NAT router to open. The default setting is 20 seconds.
Use NAT IP	The NAT IP address used in SIP/SDP messages. This field is blank at the default settings. It should ONLY be used if it's required by your ITSP.
STUN Server	The IP address or Domain name of the STUN server. STUN resolution results are displayed in the STATUS page of the Web GUI. Only non-symmetric NAT routers work with STUN.
Public Mode	Configures to turn on/off public mode for hot desking feature on the phone. If set to "Yes", users would need fill in the SIP Server address for account 1 as well. Then reboot the phone. When the phone boots up, users will need enter SIP User ID and Password on the LCD to login and use the phone. Note: When the phone is in public mode login screen, press CONF button will have the IP address of the phone displayed.
Public Mode Login Expiration	Expiration time is 0 to 24 hours. After time expiration, phone will auto log out.
Settings -> Call Features	
Off-hook Auto Dial	Configures a User ID/extension to dial automatically when the phone is off hook. The phone will use the first account to dial out. The default setting is "No".
Off-hook Timeout	If configured, when the phone is on hook, it will go off hook after the timeout (in seconds). The default value is 30 seconds.
Disable Call Waiting	Disables the call waiting feature. The default setting is "No".

Disable Call Waiting Tone	Disables the call waiting tone when call waiting is on. The default setting is "No".
Disable Direct IP Call	Disables Direct IP Call. The default setting is "No".
Use Quick IP Call mode	When set to "Yes", users can dial an IP address under the same LAN/VPN segment by entering the last octet in the IP address. To dial quick IP call, off hook the phone and dial #XXX (X is 0-9 and XXX <=255), phone will make direct IP call to aaa.bbb.ccc.XXX where aaa.bbb.ccc comes from the local IP address REGARDLESS of subnet mask. #XX or #X are also valid so leading 0 is not required (but OK). No SIP server is required to make quick IP call. The default setting is "No".
Disable Conference	Disables the Conference function. The default setting is "No".
Disable in-call DTMF Display	When it's set to "Yes", the DTMF digits entered during the call will not display. The default setting is "No".
Enable MPK sending DTMF	Enables Multi Purpose Key to send DTMF during the call. The default setting is "No".
Disable Transfer	Disables the Transfer function. The default setting is "No".
In-call dial number on pressing transfer key	Configures the number for the phone to dial as DTMF during the call using TRAN button.
Auto-Attended Transfer	If set to "Yes", the phone will use attended transfer by default. The default setting is "No".
Do Not Escape # as %23 in SIP URI	Specifies whether to replace # by %23 or not for some special situations. The default setting is "No".
Click-To-Dial Feature	Enables Click-To-Dial feature. The default setting is "Disabled".
Blink message LED on ringing	Message LED light will blink if there is an incoming call. Default value is "No".
Call History Flash Writing: Write Timeout	Defines the interval (in seconds) to save the call history to phone's flash. The default value is 300 seconds.
Call History Flash Writing: Max Unsaved Log	Defines the number of unsaved logs before written to phone's flash. The default value is 200 entries.
Settings -> Ring Tone	
Call Progresses Tones: System Ring Tone Dial Tone Second Dial Tone Message Waiting Ring Back Tone Call-Waiting Tone	Configures ring or tone frequencies based on parameters from local telecom. The default value is North American standard. Frequencies should be configured with known values to avoid uncomfortable high pitch sounds. Syntax: f1=val,f2=val[,c=on1/off1[-on2/off2[-on3/off3]]]; (Frequencies are in Hz and cadence on and off are in 10ms)

Busy Tone Reorder Tone	ON is the period of ringing ("On time" in 'ms') while OFF is the period of silence. In order to set a continuous ring, OFF should be zero. Otherwise it will ring ON ms and a pause of OFF ms and then repeat the pattern. Up to three cadences are supported.
Call Waiting Tone Gain	Configures the call waiting tone gain to adjust call waiting tone volume. The default setting is "Low".
Settings -> Audio Control	
Headset Key Mode	<p>When headset is connected to the phone, users could use the HEADSET button in "Default Mode" or "Toggle Headset/Speaker".</p> <ul style="list-style-type: none"> • Default Mode: <ul style="list-style-type: none"> ➤ When the phone is in idle, press HEADSET button to off hook the phone and make calls by using headset. Headset icon will display on the screen in dialing/talking status. ➤ When there is an incoming call, press HEADSET button to pick up the call using headset. ➤ When there is an active call using headset, press HEADSET button to hang up the call. ➤ When Speaker/Handset is being used in dialing/talking status, press HEADSET button to switch to headset. Press it again to hang up the call. Or press speaker/Handset to switch back to the previous mode. • Toggle Headst/Speaker: <ul style="list-style-type: none"> ➤ When the phone is in idle, press HEADSET button to switch to Headset mode. The headset icon will display on the left side of the screen. In this mode, if pressing Speaker button or Line key to off hook the phone, headset will be used. ➤ When there is an active call, press HEADSET button to toggle between Headset and Speaker.
Headset Type	Selects headset type from Normal RJ9 headset or Plantronics EHS headset. The default setting is "Normal".
Always Ring Speaker	Configures to enable or disable the speaker to ring when headset is used on "Toggle Headset/Speaker" mode. If set to "Yes", when the phone is in Headset "Toggle Headset/Speaker" mode, both headset and speaker will ring on incoming call. The default setting is "No".
Headset TX gain	Configures the transmission gain of the headset. The default value is 0dB.

Headset RX gain	Configures the receiving gain of the headset. The default value is 0dB.
Handset TX gain	Configures the transmission gain of the handset. The default value is 0 dB.
Settings -> LCD Display	
LCD Contrast	Configures the LCD contrast level (from 0 to 20). The default value is 10.
Settings -> Date and Time	
NTP Server	Defines the URL or IP address of the NTP server. The phone may obtain the date and time from the server.
Allow DHCP Option 42 Override NTP Server	Defines whether DHCP Option 42 should override NTP server or not. When enabled, DHCP Option 42 will override the NTP server if it's set up on the LAN. The default setting is "Yes".
Time Zone	Configures the date/time used on the phone according to the specified time zone.
Self-Defined Time Zone	<p>This parameter allows the users to define their own time zone. The syntax is: std offset dst [offset], start [/time], end [/time] Default is set to: MTZ+6MDT+5,M4.1.0,M11.1.0</p> <p>MTZ+6MDT+5 This indicates a time zone with 6 hours offset with 1 hour ahead which is U.S central time. If it is positive (+) if the local time zone is west of the Prime Meridian (A.K.A: International or Greenwich Meridian) and negative (-) if it is east.</p> <p>M4.1.0,M11.1.0 The 1st number indicates Month: 1,2,3..., 12 (for Jan, Feb, ..., Dec) The 2nd number indicates the nth iteration of the weekday: (1st Sunday, 3rd Tuesday...) The 3rd number indicates weekday: 0,1,2,...,6(for Sun, Mon, Tues, ... ,Sat) Therefore, this example is the DST which starts from the First Sunday of April to the 1st Sunday of November.</p>
Date Display Format	<p>Configures the date display format on the LCD. The following formats are supported:</p> <ul style="list-style-type: none"> • yyyy-mm-dd: 2012-07-02 • mm-dd-yyyy: 07-02-2012 • dd-mm-yyyy: 02-07-2012 • dddd, MMMM dd: Friday, October 12 • MMMM dd, dddd: October 12, Friday
Time Display Format	Configures the time display in 12-hour or 24-hour format on the LCD. The

	default setting is in 12-hour format.
--	---------------------------------------

Settings -> Web Service

Enable Weather Update	Configures to enable or disable weather update on the phone. The default setting is "Yes". If set to "No", the weather information screen will not show.
City Code	Configures weather city code for the phone to look up the weather information. The default setting is "Automatic" and the weather information will be obtained based on the IP location of the phone if available. Otherwise, specify the self-defined city code. For example, USCA0638 is the city code for Los Angeles, CA, United States.
Update Interval	Specifies the weather update interval (in minutes). The default value is 15 minutes.
Degree Unit	Specifies the degree unit for the weather information to display on the phone.

Settings -> XML Applications

Idle Screen XML Download	Configures to enable idle screen XML download. Users could select HTTP/HTTPS/TFTP to download the XML idle screen file. The default setting is "No".
Download Screen XML At Bootup	If set to "Yes", the idle screen XML file will be downloaded when the phone boots up. The default setting is "No".
User Custom Filename	Specifies the custom file for the idle screen XML file to be downloaded.
Idle Screen XML Server Path	Configures the server path to download the idle screen XML file. This field could be IP address or URL, with up to 256 characters.

NETWORK PAGE DEFINITIONS

Network -> Basic Settings

Internet Protocol	Selects Prefer IPv4 or Prefer IPv6.
IPv4 Address Type	Allows users to configure the appropriate network settings on the phone to obtain IPv4 address. Users could select "DHCP", "Static IP" or "PPPoE". By default, it is set to "DHCP".
DHCP Host name (Option 12)	Specifies the name of the client. This field is optional but may be required by some Internet Service Providers.
DHCP Vendor Class ID (Option 60)	Used by clients and servers to exchange vendor class ID.
PPPoE Account ID	Enter the PPPoE account ID.

PPPoE Password	Enter the PPPoE Password.
PPPoE Service Name	Enter the PPPoE Service Name.
IPv4 Address	Enter the IP address when static IP is used.
Subnet Mask	Enter the Subnet Mask when static IP is used for IPv4.
Gateway	Enter the Default Gateway when static IP is used for IPv4.
DNS Server 1	Enter the DNS Server 1 when static IP is used for IPv4.
DNS Server 2	Enter the DNS Server 2 when static IP is used for IPv4.
Preferred DNS Server	Enter the Preferred DNS Server for IPv4.
IPv6 Address Type	Allows users to configure the appropriate network settings on the phone to obtain IPv6 address. Users could select "Auto-configured" or "Statically configured" for the IPv6 address type.
Static IPv6 Address	Enter the static IPv6 address when Full Static is used in "Statically configured" IPv6 address type.
IPv6 Prefix Length	Enter the IPv6 prefix length when Full Static is used in "Statically configured" IPv6 address type.
IPv6 Prefix	Enter the IPv6 Prefix (64 bits) when Prefix Static is used in "Statically configured" IPv6 address type.
DNS Server 1	Enter the DNS Server 1 for IPv6.
DNS Server 2	Enter the DNS Server 2 for IPv6.
Preferred DNS server	Enter the Preferred DNS Server for IPv6.
Network -> Advanced Settings	
802.1X mode	Allows the user to enable/disable 802.1X mode on the phone. The default value is disabled. To enable 802.1X mode, this field should be set to EAP-MD5.
802.1X Identity	Enter the Identity for the 802.1X mode.
MD5 Password	Enter the MD5 Password for the 802.1X mode.
802.1X CA Certificate	Upload 802.1X CA certificate to the phone; or delete existed 802.1X CA certificate from the phone.
802.1X Client Certificate	Upload 802.1X Client certificate to the phone; or delete existed 802.1X Client certificate from the phone.
HTTP Proxy	Specifies the HTTP proxy URL for the phone to send packets to. The proxy server will act as an intermediary to route the packets to the destination.
HTTPS Proxy	Specifies the HTTPS proxy URL for the phone to send packets to. The proxy server will act as an intermediary to route the packets to the

	destination.
Layer 3 QoS	Defines the Layer 3 QoS parameter. This value is used for IP Precedence, Diff-Serv or MPLS. The default value is 12.
Layer 2 QoS 802.1Q/VLAN Tag	Assigns the VLAN Tag of the Layer 2 QoS packets. The default value is 0.
Layer 2 QoS 802.1p Priority Value	Assigns the priority value of the Layer2 QoS packets. The default value is 0.
PC Port Mode	Configures the PC port mode. When set to "Mirrored", the traffic in the LAN port will go through PC port as well and packets can be captured by connecting a PC to the PC port. The default setting is "Enable".
Enable LLDP	Controls the LLDP (Link Layer Discovery Protocol) service.

MAINTENANCE PAGE DEFINITIONS

Maintenance -> Web Access

End User Password	Allows the administrator to set the password for user-level web GUI access. This field is case sensitive with a maximum length of 30 characters.
Confirm Password	Confirms the end user password field to be the same as above.
Admin Password	Allows users to change the admin password. The password field is purposely hidden after clicking the Update button for security purpose. This field is case sensitive with a maximum length of 30 characters.
Confirm Password	Confirms the admin password field to be the same as above.

Maintenance -> Upgrade and Provisioning

Firmware Upgrade and Provisioning	Specifies how firmware upgrading and provisioning request to be sent: Always Check for New Firmware, Check New Firmware only when F/W pre/suffix changes, Always Skip the Firmware Check.
XML Config File Password	The password for encrypting the XML configuration file using OpenSSL. This is required for the phone to decrypt the encrypted XML configuration file.
HTTP/HTTPS User Name	The user name for the HTTP/HTTPS server.
HTTP/HTTPS Password	The password for the HTTP/HTTPS server.
Upgrade Via	Allows users to choose the firmware upgrade method: TFTP, HTTP or HTTPS.
Firmware Server Path	Defines the server path for the firmware server. It could be different from the configuration server for provisioning.
Config Server Path	Defines the server path for provisioning. It could be different from the firmware server for upgrading.

Firmware File Prefix	This field enables user to store different versions of firmware files in one single directory on the firmware server. If configured, only the firmware file with the matching prefix will be downloaded.
Firmware File Postfix	This field enables user to store different versions of firmware files in one single directory on the firmware server. If configured, only the firmware file with the matching postfix will be downloaded.
Config File Prefix	This field enables user to store different configuration files in one single directory on the configuration server. If configured, only the configuration file with the matching prefix will be downloaded.
Config File Postfix	This field enables user to store different configuration files in one single directory on the configuration server. If configured, only the configuration file with the matching postfix will be downloaded.
Hoteling Event and Option 66 Override Server	Default setting is "Yes". DHCP option 66 originally was only designed for TFTP server. Later on it was extended to support an HTTP URL. GXP phones support both TFTP and HTTP server via option 66. Users can also use DHCP option 43 vendor specific option to do this. DHCP option 43 approach has priorities.
Allow DHCP Option 120 to override SIP Server	Enables DHCP Option 120 from local server to override the SIP Server on the phone. The default setting is "No".
3CX Auto Provision	Phone will multicast SUBSCRIBE for provision if this feature is enabled.
Automatic Upgrade	Enables automatic upgrade and provisioning. The default setting is "No".
Hour of the Day (0-23)	Defines the hour of the day to check the HTTP/TFTP server for firmware upgrades or configuration files changes. The default value is 1.
Day of the Week (0-6)	Defines the day of the week to check HTTP/TFTP server for firmware upgrades or configuration files changes. The default value is 1.
Authenticate Conf File	Authenticates configuration file before acceptance. The default setting is "No".
Maintenance -> Syslog	
Syslog Server	The URL or IP address of the syslog server for the phone to send syslog to.
Syslog Level	<p>Selects the level of logging for syslog. The default setting is "None". There are 4 levels: DEBUG, INFO, WARNING AND ERROR.</p> <p>Syslog messages are sent based on the following events:</p> <ul style="list-style-type: none"> • product model/version on boot up (INFO level); • NAT related info (INFO level); • sent or received SIP message (DEBUG level); • SIP message summary (INFO level); • inbound and outbound calls (INFO level); • registration status change (INFO level);

	<ul style="list-style-type: none"> • negotiated codec (INFO level); • ethernet link up (INFO level); • SLIC chip exception (WARNING and ERROR levels); • memory exception (ERROR level).
Send SIP Log	Configures whether the SIP log will be included in the syslog messages or not. The default setting is "No".
Auto Recover From Abnormal	Configures whether auto recover or not when the phone is running abnormal. The default setting is "Yes".
Maintenance -> Language	
Display Language	Selects display language on the phone.
Language File Postfix	Specifies the language file postfix for downloaded language.
Maintenance -> TR-069	
Enable TR-069	Enables TR-069. The default setting is "No".
ACS URL	URL for TR-069 Auto Configuration Servers (ACS).
TR-069 Username	ACS username for TR-069.
TR-069 Password	ACS password for TR-069.
Periodic Inform Enable	Enables periodic inform. If set to "Yes", device will send inform packets to the ACS. The default setting is "No".
Periodic Inform Interval	Sets up the periodic inform interval to send the inform packets to the ACS.
Connection Request Username	The user name for the ACS to connect to the phone.
Connection Request Password	The password for the ACS to connect to the phone.
Connection Request Port	The port for the ACS to connect to the phone.
CPE SSL Certificate	The Cert File for the phone to connect to the ACS via SSL.
CPE SSL Private Key	The Cert Key for the phone to connect to the ACS via SSL.
Maintenance -> Security	
Configuration via Keypad Menu	<p>Configures the access control for the users to configure from keypad Menu. There are three different modes:</p> <ul style="list-style-type: none"> • Unrestricted. All the options can be accessed in keypad Menu. This mode is for administrator using. • Basic settings only. The "Config" option will not be available in LCD Menu. • Constraint Mode. "Config", "Factory Functions" and "Network" options will not be available in LCD menu, while "Admin Login" will appear. By entering administrator password for "Admin Login", administrator can

	unlock the hidden options for one time usage.
Enable STAR key Keypad locking	<p>If set to "Yes", the keypad can be locked by pressing and holding the STAR * key for about 4 seconds. A lock icon will show indicating the keypad is locked. The default setting is "Yes".</p> <p>Note: When the keypad is locked, users would need press and hold the STAR * key for about 4 seconds again and then enter the password to unlock it. If the Star Key Lock is enabled without specifying password, user can press and hold the STAR * key for 4 seconds and press OK to unlock the phone.</p>
Password to lock/unlock	Configures the password to lock/unlock the keypad. The password field allows number with up to 32 characters.
SIP TLS Certificate	SSL Certificate used for SIP TLS Transport.
SIP TLS Private Key	SSL Private key used for SIP TLS Transport.
SIP TLS Private Key Password	SSL Private key password used for SIP TLS Transport.
Download Device Configuration	Click to download the device configuration file in .txt format.
Web Access Mode	Sets the protocol for web interface as HTTP or HTTPS. Default setting is HTTP.
Disable SSH	Disable SSH access. SSH is enabled by default.

PHONEBOOK PAGE DEFINITIONS

Phonebook -> Contacts

Add Contact	Specify Contact's First Name, Last Name, Phone Number, Accounts and Groups to add one new contact in phonebook.
-------------	---

Phonebook -> Phonebook Management

Enable Phonebook XML Download	Configures to enable phonebook XML download. Users could select HTTP/HTTPS/TFTP to download the phonebook file. The default setting is "Disabled".
Phonebook XML Server Path	Configures the server path to download the phonebook XML. This field could be IP address or URL, with up to 256 characters.
Phonebook Download Interval	Configures the phonebook download interval (in minutes). If it's set to 0, the automatic download will be disabled. The default value is 0. The valid range is 5 to 720 minutes.
Remove Manually-edited	If set to "Yes", when XML phonebook is downloaded, the entries added

Entries on Download	manually will be automatically removed. The default setting is "Yes".
Sort Phonebook by.	Sort the phonebook on the selection of first name or last name.
Download XML Phonebook	Click on "Download" to download the XML phonebook file to local PC.
Upload XML Phonebook	Click on "Upload" to upload local XML phonebook file to the phone.
Phonebook Key Function	Controls the behavior of Phonebook key.
Phonebook -> LDAP	
Server Address	Configures the IP address or DNS name of the LDAP server.
Port	Configures the LDAP server port.
Base	Configures the LDAP search base. This is the location in the directory where the search is requested to begin. Example: dc=grandstream, dc=com ou=Boston, dc=grandstream, dc=com
User Name	Configures the bind "Username" for querying LDAP servers. Some LDAP servers allow anonymous binds in which case the setting can be left blank.
Password	Configures the bind "Password" for querying LDAP servers. The field can be left blank if the LDAP server allows anonymous binds.
LDAP Number Filter	Configures the filter used for number lookups. Examples: (!(telephoneNumber=%)(Mobile=%) returns all records which has the "telephoneNumber" or "Mobile" field starting with the entered prefix; (&(telephoneNumber=%) (cn=*)) returns all the records with the "telephoneNumber" field starting with the entered prefix and "cn" field set.
LDAP Name Filter	Configures the filter used for name lookups. Examples: (!(cn=%)(sn=%)) returns all records which has the "cn" or "sn" field starting with the entered prefix; (!(sn=%)) returns all the records which do not have the "sn" field starting with the entered prefix; (&(cn=%) (telephoneNumber=*)) returns all the records with the "cn" field starting with the entered prefix and "telephoneNumber" field set.
LDAP Version	Selects the protocol version for the phone to send the bind requests. The default setting is "Version 3".

LDAP Name Attributes	Specify the "name" attributes of each record which are returned in the LDAP search result. This field allows the users to configure multiple space separated name attributes. Example: gn cn sn description
LDAP Number Attributes	Specifies the "number" attributes of each record which are returned in the LDAP search result. This field allows the users to configure multiple space separated number attributes. Example: telephoneNumber telephoneNumber Mobile
LDAP Display Name	Configures the entry information to be shown on phone's LCD. Up to 3 fields can be displayed. Example: %cn %sn %telephoneNumber
Max. Hits	Specifies the maximum number of results to be returned by the LDAP server. If set to 0, server will return all search results. The default setting is 50.
Search Timeout	Specifies the interval (in seconds) for the server to process the request and client waits for server to return. The default setting is 30 seconds.
Sort Results	Specifies whether the searching result is sorted or not. The default setting is "No".
LDAP Lookup	Configures to enable LDAP number searching when dialing and receiving calls.
Lookup Display Name	Configures the display name when LDAP looks up the name for incoming call or outgoing call. This field must be a subset of the LDAP Name Attributes. Example: gn cn sn description

NAT SETTINGS

If the devices are kept within a private network behind a firewall, we recommend using STUN Server. The following settings are useful in the STUN Server scenario:

- **STUN Server**

Under **Settings->General Settings**, enter a STUN Server IP (or FQDN) that you may have, or look up a free public STUN Server on the internet and enter it on this field. If using Public IP, keep this field blank.

- **Use Random Ports**

It is under **Settings->General Settings**. This setting depends on your network settings. When set to "Yes", it will force random generation of both the local SIP and RTP ports. This is usually necessary when multiple GXPs are behind the same NAT. If using a Public IP address, set this parameter to "No".

- **NAT Traversal**

It is under **Accounts X->Network Settings**. Default setting is "No". Enable the device to use NAT traversal when it is behind firewall on a private network. Select Keep-Alive, Auto, STUN (with STUN server path configured too) or other option according to the network setting.

WEATHER UPDATE

To customize GXP1160/GXP1165 to display weather information for the preferred city, users could go to web GUI->**Settings->Web Service** page and enter the city code in the following options:

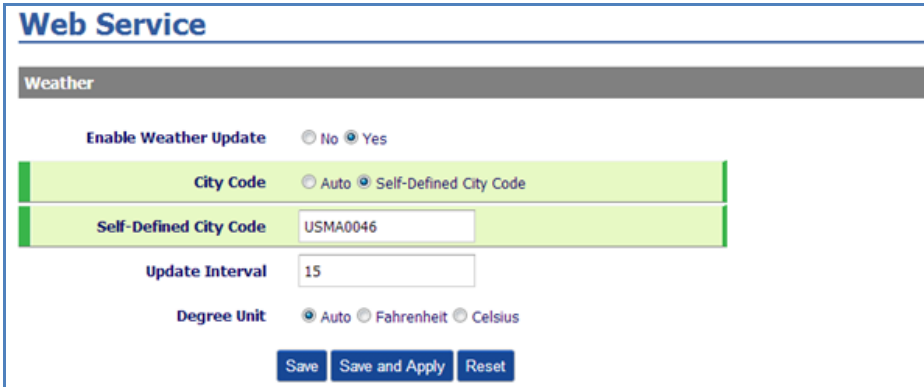

The screenshot shows the 'Web Service' configuration page with a 'Weather' section. The 'Enable Weather Update' option is set to 'Yes'. The 'City Code' option is set to 'Self-Defined City Code', and the 'Self-Defined City Code' field contains 'USMA0046'. The 'Update Interval' is set to '15'. The 'Degree Unit' option is set to 'Auto'. At the bottom, there are three buttons: 'Save', 'Save and Apply', and 'Reset'.

Figure 4: Weather Update

By default the City Code is set to "**Automatic**", which allows the phone to obtain weather information based on the IP location detected. To use "**Self-Defined City Code**" option, please follow the steps below to obtain the correct city code:

- In a web browser, go to www.weather.com;
- Enter the city name in the search field. For example, Boston, MA. And click on "SEARCH";

- The searching result will show in a new window with URL in the browser's address bar. For example, <http://www.weather.com/weather/right-now/Boston+MA+USMA0046>
- In the above link, **USMA0046** is the city code to be filled in "**Self-Defined City Code**" option.

Users could then further configure the "**Update Interval**" and "**Degree Unit**" for weather information display.

PUBLIC MODE

The GXP1160/GXP1165 supports hot desking using public mode. Under public mode, users could login the phone with the SIP account User ID and password. Please follow the steps below to configure the phone for public mode:

- Fill up the SIP server address for Account 1 first;
- Under Web GUI->**Settings**->**General Settings**, set "Public Mode" option to "Yes". Click "Save and Apply" and reboot the phone;
- When the phone boots up, SIP User ID and Password to register to the configured SIP server in account 1 will be required. Enter the correct account information to log in to the phone. When entering the account information, press softkey "123"/"abc" to toggle input method;
- In login page, pressing CONF button on the phone will show phone's IP address;
- After using the phone, go to LCD MENU->LogOut to log off the public mode.

EDITING CONTACTS AND CLICK-TO-DIAL

From GXP1160/GXP1165 Web GUI, users could view contacts, edit contacts, or dial out with Click-to-Dial feature  on the top of the Web GUI. In the following figure, the Contact page shows all the added contacts (manually or downloaded via XML phonebook). Here users could add new contact, edit selected contact, or dial the contact/number.

Before using the Click-To-Dial feature, make sure the option "Click-To-Dial Feature" under web GUI->**Settings**->**Call Features** is turned on. By default it's disabled and the dialing icon in web GUI is in grey .

When clicking on the  icon on the top menu of the Web GUI, a new dialing window will show for you to enter the number. Once Dial is clicked, the phone will go off hook and dial out the number from selected account.

Additionally, users could directly send the command for the phone to dial out by specifying the following URL in PC's web browser, or in the field as required in other call modules.

http://ip_address/cgi-bin/api-make_call?phonenumber=1234&account=0&password=admin/123

In the above link, replace the **fields** with

- **ip_address**:
Phone's IP Address.
- **phonenumber=1234**:
The number for the phone to dial out
- **account=0**:
The account index for the phone to make call. The index is 0 for account 1, 1 for account 2, 2 for account 3, and etc.
- **password=admin/123**:
The admin login password or user login password of phone's Web GUI.

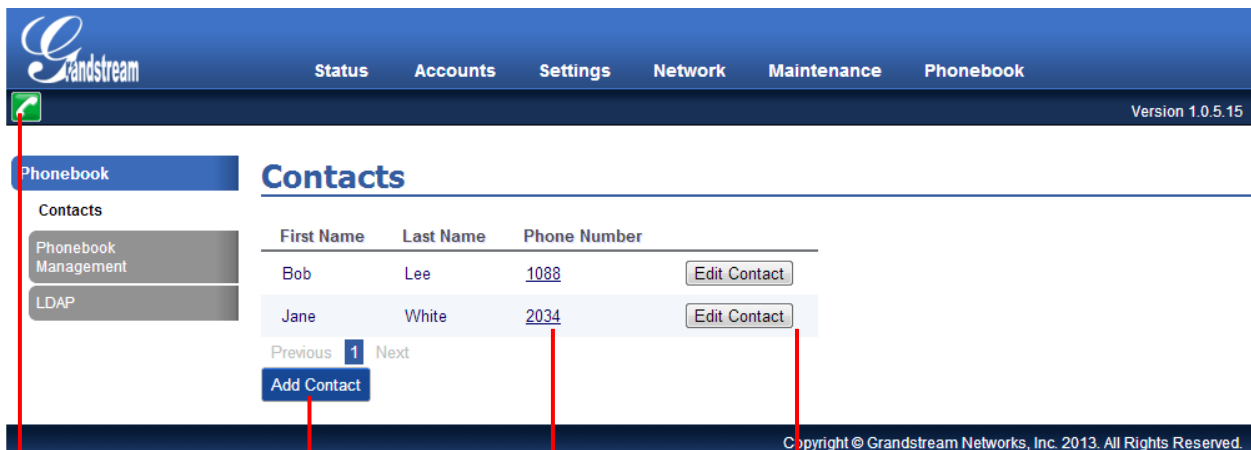

The screenshot shows the Grandstream Web GUI interface. At the top, there is a navigation bar with the Grandstream logo and menu items: Status, Accounts, Settings, Network, Maintenance, and Phonebook. Below the navigation bar, the main content area is titled "Contacts". On the left side, there is a sidebar with "Phonebook" selected, and sub-items for "Contacts", "Phonebook Management", and "LDAP". The main "Contacts" area contains a table with the following data:

First Name	Last Name	Phone Number	
Bob	Lee	1088	Edit Contact
Jane	White	2034	Edit Contact

Below the table, there are navigation links: "Previous 1 Next" and an "Add Contact" button. At the bottom of the page, there is a copyright notice: "Copyright © Grandstream Networks, Inc. 2013. All Rights Reserved." Four red lines with arrows point from the table and sidebar to the following text:

- Click to dial from available lines.
- Add contacts.
- Click to call this contact from the phone.
- Edit contact.

Figure 5: Web GUI - Phonebook->Contacts

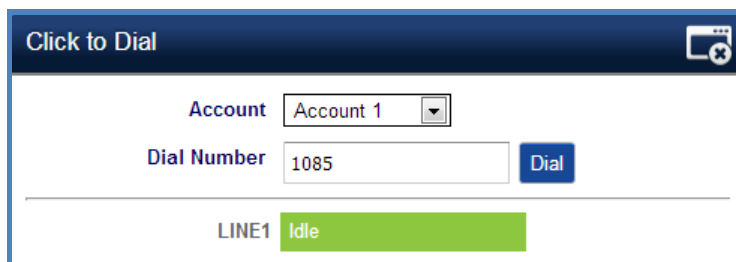

Click to Dial

Account Account 1

Dial Number 1085 Dial

LINE1 Idle

Figure 6: Click-to-Dial

SAVING THE CONFIGURATION CHANGES

After users makes changes to the configuration, press the "Save" button will save but not apply the changes until the "Apply" button on the top of web GUI page is clicked. Or, users could directly press "Save and Apply" button. We recommend rebooting or powering cycle the phone after applying all the changes.

REBOOTING FROM REMOTE LOCATIONS

Press the "Reboot" button on the top right corner of the web GUI page to reboot the phone remotely. The web browser will then display a reboot message. Wait for about 1 minute to log in again.

UPGRADING AND PROVISIONING

The GXP1160/GXP1165 can be upgraded via TFTP/HTTP/HTTPS by configuring the URL/IP Address for the TFTP/HTTP/HTTPS server and selecting a download method. Configure a valid URL for TFTP or HTTP/HTTPS; the server name can be FQDN or IP address.

Examples of valid URLs:

firmware.grandstream.com

fw.ipvideotalk.com/gs

There are two ways to setup a software upgrade server: The LCD Keypad Menu or the Web Configuration Interface.

UPGRADE VIA KEYPAD MENU

Follow the steps below to configure the upgrade server path via phone's keypad menu:

- Press MENU button and navigate using Up/Down arrow to select **Config**;
- In the Config options, select **Upgrade**;
- Enter the firmware server path and select upgrade method. The server path could be in IP address format or FQDN format;
- Press the "OK" softkey. A reboot message window will be prompt;
- Reboot the phone to have the change take effect.

When upgrading starts, the screen will show upgrading progress. When done you will see the phone restarts again. Please do not interrupt or power cycle the phone when the upgrading process is on.

UPGRAGE VIA WEB GUI

Open a web browser on PC and enter the IP address of the phone. Then, login with the administrator username and password. Go to **Maintenance->Upgrade and Provisioning** page, enter the IP address or the FQDN for the upgrade server in "Firmware Server Path" field and choose to upgrade via TFTP or HTTP/HTTPS. Update the change by clicking the "Save and Apply" button. Then "Reboot" or power cycle the phone to update the new firmware.

When upgrading starts, the screen will show upgrading progress. When done you will see the phone

restart again. Please do not interrupt or power cycle the phone when the upgrading process is on.

Firmware upgrading takes around 60 seconds in a controlled LAN or 5-10 minutes over the Internet. We recommend completing firmware upgrades in a controlled LAN environment whenever possible.

NO LOCAL TFTP/HTTP SERVERS

For users that would like to use remote upgrading without a local TFTP/HTTP server, Grandstream offers a NAT-friendly HTTP server. This enables users to download the latest software upgrades for their phone via this server. Please refer to the webpage:

<http://www.grandstream.com/support/firmware>

Alternatively, users can download a free TFTP or HTTP server and conduct a local firmware upgrade. A free windows version TFTP server is available for download from :

http://www.solarwinds.com/products/freetools/free_tftp_server.aspx

<http://tftpd32.jounin.net/>.

Instructions for local firmware upgrade via TFTP:

1. Unzip the firmware files and put all of them in the root directory of the TFTP server;
2. Connect the PC running the TFTP server and the phone to the same LAN segment;
3. Launch the TFTP server and go to the File menu->Configure->Security to change the TFTP server's default setting from "Receive Only" to "Transmit Only" for the firmware upgrade;
4. Start the TFTP server and configure the TFTP server in the phone's web configuration interface;
5. Configure the Firmware Server Path to the IP address of the PC;
6. Update the changes and reboot the phone.

End users can also choose to download a free HTTP server from <http://httpd.apache.org/> or use Microsoft IIS web server.

CONFIGURATION FILE DOWNLOAD

Grandstream SIP Devices can be configured via the Web Interface as well as via a Configuration File (binary or XML) through TFTP or HTTP/HTTPS. The "Config Server Path" is the TFTP or HTTP/HTTPS server path for the configuration file. It needs to be set to a valid URL, either in FQDN or IP address format. The "Config Server Path" can be the same or different from the "Firmware Server Path".

A configuration parameter is associated with each particular field in the web configuration page. A parameter consists of a Capital letter P and 2 to 3 (Could be extended to 4 in the future) digit numeric

numbers. i.e., P2 is associated with the "Admin Password" in the Web GUI->Maintenance->Web/Telnet Access page. For a detailed parameter list, please refer to the corresponding firmware release configuration template.

When GXP1160/GXP1165 boots up, it will send TFTP or HTTP/HTTPS requests to download configuration files, "cfg000b82xxxxx" and "cfg000b82xxxxx.xml", where "000b82xxxxx" is the MAC address of the phone. If the download of "cfgxxxxxxxxxxxx.xml" is not successful, phone will issue request for a generic configuration file "cfg.xml". Configuration file name should be in lower case letters.

For more details on XML provisioning, please refer to:

http://www.grandstream.com/general/gs_provisioning_guide_public.pdf

RESTORE FACTORY DEFAULT SETTINGS

Warning:

Restoring the Factory Default Settings will delete all configuration information on the phone. Please backup or print all the settings before you restore to the factory default settings. Grandstream is not responsible for restoring lost parameters and cannot connect your device to your VoIP service provider.

Please follow the instructions below to reset the phone:

- Press MENU button to bring up the keypad configuration menu;
- Select "Config" and enter;
- Select "Factory Reset";
- A warning window will pop out to make sure a reset is requested and confirmed;
- Press the "OK" softkey to confirm and the phone will reboot. To cancel the Reset, press Cancel softkey instead.

EXPERIENCING THE GXP1160/GXP1165

Please visit our website: <http://www.grandstream.com> to receive the most up- to-date updates on firmware releases, additional features, FAQs, documentation and news on new products.

We encourage you to browse our [product related documentation](#), [FAQs](#) and [User and Developer Forum](#) for answers to your general questions. If you have purchased our products through a Grandstream Certified Partner or Reseller, please contact them directly for immediate support.

Our technical support staff is trained and ready to answer all of your questions. Contact a technical support member or [submit a trouble ticket online](#) to receive in-depth support.

Thank you again for purchasing Grandstream IP phone, it will be sure to bring convenience and color to both your business and personal life.