

## GV-SD200-S Outdoor Full HD IP Speed Dome



- 2 MP progressive scan CMOS
- 18x Optical Zoom
- 10x Digital Zoom
- H.264 and MJPEG
- Dual streams
- Full HD Real-time Resolution
- Two-way audio support on Web interface
- Removable IR Cut Filter
- Motion Detection
- Schedules for motion detection and alarm functions
- P-Iris Mode for camera exposure
- Wide Dynamic Range Pro (WDR Pro)
- Digital Noise Reduction
- Ingress protection (IP66)
- ONVIF (Profile S) conformant
- 11 languages on Web interface

\* No SD/SDHC card slot & local storage function for Argentina

### Introduction

The full HD GV-IP Speed Dome provides variable pan/tilt speeds ranging from a fast patrol of 400° per second to a slow rotation of 5° per second with 0.225° pan accuracy for fast and accurate tracking ability. The 360° endless rotation and -10°~190° tilt travel can track objects passing directly beneath the GV-IP Speed Dome. A maximum of 256 preset points can be programmed for precise location of target areas, and users can also define 8 sequences, 4 auto-pan modes and 4 cruise routes for the Dome to operate automatically.

The GV-IP Speed Dome provides 4 alarm inputs and 2 alarm relay outputs, and the alarm management can be done through the network as well.

### Overview

- Dimensions

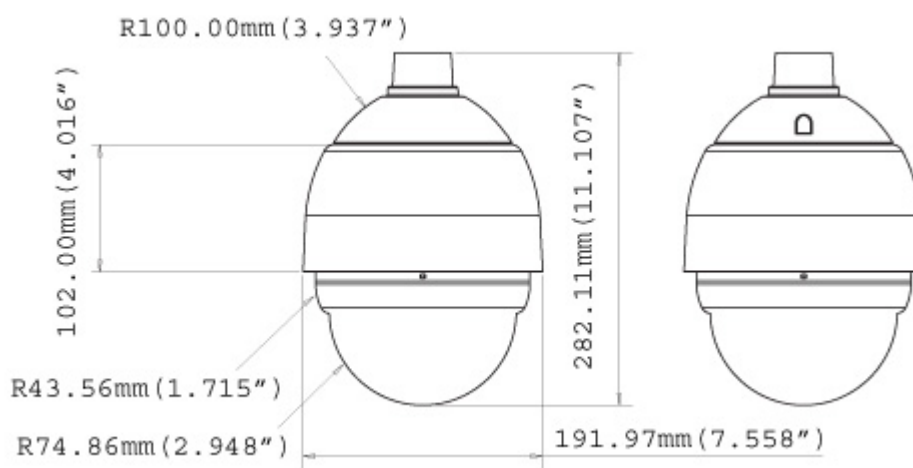

- Panel



## Specifications

Camera		
Sensor	1/2.8" Progressive Scan CMOS Sensor	
Optical Zoom	18X	
Digital Zoom	1~10x variable	
White Balance	Auto/ Indoor/ Outdoor/ ATW	
Iris Control	Auto / Manual	
Electronic Shutter	1/30 ~ 1/10000 sec.	
AGC control	Auto / Manual	
Back Light	On / Off	
Minimum Illumination	Color	0.05 lux at F/1.6
	B/W	0.01 lux at F/1.6
Optical Lens		
Megapixel	Yes	
Day / Night	Yes (with removable IR-cut filter)	
Focal Length	4.7 ~ 84.6 mm	
Maximum Aperture	F/1.6 to F/28	
Focus Mode	Auto / Manual	
Operation	Focus	Auto / Manual
	Zoom	
	Iris	
Video		
Video Codec	H.264, MJPEG	
Video Streaming	Dual Stream *Dual streaming is only supported when stream 1 is set to H.264.	
Video Resolution	4:3	1024 x 768, 800 x 600, 640 x 480
	16:9	1920 x 1080, 1280 x 720
	5:4	1280 x 1024
	D1	720 x 576 / 720 x 480
	CIF	352 x 288 / 352 x 240
Frame Rate	30/25 fps (60/50 Hz) at 1920 x 1080	
Audio		
Audio input/output	Two-way audio on Web interface	
Audio Codec	G.711	
Network		
Interface	10/100 Mb Ethernet (RJ-45)	
Protocol	IPv4, TCP/IP, UDP, RTP, RTSP, HTTP, HTTPS, ICMP, FTP, SMTP, DHCP, UPnP, IGMP, SNMP, QoS, ONVIF (Profile S)	

Mechanical		
Temperature Detector		No
Connectors	Power	3-pin terminal block
	Ethernet	Ethernet (10/100 Base-T), RJ-45 Connector
	Audio	1 in 1 out (terminal block)
	Digital I/O	4 in 2 out (12-pin terminal block)
	Local Storage	Micro SD/SDHC memory card slot (for Class 6 card or above) *SDXC and UHS-I card types are not supported.
Operation		
Pan Travel		360° endless
Tilt Travel		-10° ~ 190°
Manual Speed		0.5° ~ 90°/s
Presets		256
Preset Accuracy		0.225°
Preset Speed		5°~400°/s
Sequence		8
Auto Pan		4
Cruise		8
Privacy Mask		16
Proportional Pan & Tilt		On / Off (Pan and tilt speed proportional to zoom ratio)
Resume after Power loss		Yes
Network Failure Detection		On / Off
Operation		
Automatic Function		Preset, Sequence, Auto Pan, Cruise, Tour
Auto Flip		Digital / Mechanical / Off
Digital Slow Shutter		On / Off
Motion Detection		4
Schedule		10
Wide Dynamic Range		On / Off
Day/Night: IR Cut Filter		Auto / Manual
Digital Noise Reduction		On / Off
Digital Alarm Input		4
Digital Alarm Output		2
Alarm Reaction		Preset, Sequence, Auto Pan, Cruise
General		
Operating Temperature		-40°C ~ 50°C (40°F ~ 122°F)
Heater		On: -7°C (19.4°F) Off: 3°C (37.4°F)
Dimensions		∅ 191.97 x 282.11 mm (7.55" x 11.1") (with sunshield)
Weight		2.32 kg (5.11 lb) (with sunshield)
Power Source		AC24V ± 10%
Power Consumption		65 W (with heater)
Ingress Protection		IP66
Regulatory		CE, FCC, RoHS
Web Interface		
Installation Management		Web-based configuration
Maintenance		Firmware upgrade through Web Browser
Language		English, French, German, Italian, Japanese, Korean, Portuguese, Russian, Simplified Chinese, Spanish and Traditional Chinese





**Note:** Specifications are subject to change without notice.

**Accessories**

Part Number	Number Name		Details
GV-MountD100	Straight Tube (25 cm)		Height: 250 mm (9.8") Diameter: 50 mm (2") Weight: 1 kg (2.2 lb) Supplied with rubber washer-8 x 1, pendent tube washer x 1, spring washer -8 x 1, waterproof rubber x 1, M8-12 screw x 1
GV-MountD101	Straight Tube (50 cm)		Height: 500 mm (19.7") Diameter: 50 mm (2") Weight: 1.8 kg (4 lb) Supplied with rubber washer-8 x 1, pendent tube washer x 1, spring washer -8 x 1, waterproof rubber x 1, M8-12 screw x 1
GV-MountD203 (w/o anti-drop wire)	Standard Pendent Mount		Dimensions (L x W x D): 348 x 104 x 138.6 mm (13.7" x 4.1" x 5.5") Weight: 1.5 kg (3.3 lb) Supplied with rubber washer-8 x 1, pendent tube washer x 1, spring washer-8 x 1, M8-12 screw x 1
GV-MountD300	Corner Plate Mount		Dimensions (L x W x D): 222 x 204 x 117 mm (8.7" x 8" x 4.6") Weight: 2 kg (4.4 lb) Supplied with washer-8 x 4, spring washer x 4, M8-16 screw x 4, M8 nut x 4
GV-MountD301	Corner Thin Box Mount		Dimensions (L x W x D): 300 x 164 x 222 mm (11.8" x 6.5" x 8.7") Weight: 3.05 kg (6.7 lb) Supplied with washer x 4, M8-16 screw x 4, spring washer x 4 Power Box can be set inside the thin box.
GV-MountD400	Pole Thin Box Mount		Dimensions (L x W x D): 291 x 136 x 242 mm (11.5" x 5.4" x 9.5") Weight: 3.1 kg (6.9 lb) Supplied with M8-16 screw x 4, washer x 4, spring washer x 4, stainless steel straps x 4 Power Box can be set inside the thin box.
GV-MountD401	Pole Thin Direct Mount		Dimensions (L x W x D): 232 x 136 x 60 mm (9.1" x 5.4" x 2.4") Diameter: 112~114 mm (4.4" ~ 4.5") Weight: 0.7 kg (1.6 lb) Supplied with stainless steel strap x 4, M8-16 screw x 4, washer x 4
GV-MountD302	Wall Box Mount		Dimensions (L x W x D): 270 x 166 x 95 mm (10.6" x 6.5" x 3.7") Weight: 2.2 kg (4.84 lb) Supplied with M8-16 screw x 4, washer x 4, spring washer x 4 Power Box can be set inside the wall box.
GV-MountD605	5.8" Smoke Cover		Diameter: 145 mm (5.7")

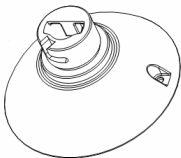
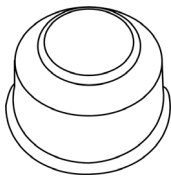
Part Number	Number Name		Details
GV-MountD500	Power Box (Input: 110 -115V AC)		Dimensions (L x W): 185.5 x 147 mm (7.3" x 5.8") Weight: 2.6 kg (5.8 lb) Output: 24VAC 72VA
GV-MountD501	Power Box (Input: 220 -230V AC)		Dimensions (L x W): 185.5 x 147 mm (7.3" x 5.8") Weight: 2.6 kg (5.8 lb) Output: 24VAC 72VA
	Power Adaptor (Input: 100-115V AC)		Dimensions (L x W): 131 x 90 mm (5.16" x 3.54") Weight: 1.47 kg (3.23 lb) Output: 24V AC 3A
	Power Adaptor (Input: 220-230V AC)		Dimensions (L x W): 131 x 90 mm (5.16" x 3.54") Weight: 1.47 kg (3.23 lb) Output: 24V AC 3A
GV-MountD202 (w/o anti-drop wire)	Mini Pendant Mount		(included in packing list) Dimensions (L x W x D): 184 x 104 x 115.2 mm (7.24" x 4.09" x 4.54") Weight: 0.6 kg (1.2 lb) Supplied with rubber washer-8 x 1, pendant tube washer x 1, spring washer-8 x 1, M8-12 screw x 1
GV-MountD902	Outdoor Mounting Kit		( included in packing list) Height: 73 mm (2.87") Diameter: 142.58 mm (5.6") Weight: 0.26 kg (0.57 lb) Supplied with Waterproof Rubber, T5/T10 Hexagon Key, M5 Stainless Screw x1, M5 Stainless Tamperproof Screw x1

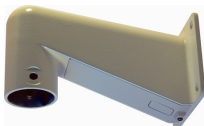
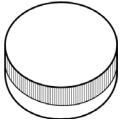
**Packing List**

 <p>Camera Body</p>	 <p>Outdoor Mounting Kit GV-MountD902</p>	 <p>Waterproof Rubber</p>
 <p>M3 Standard Screw (x1) M3 Security Screw (x1) M5 Standard Screw (x1) M5 Security Screw (x1)</p>	 <p>Mini Pendant Mount (GV-MountD202)</p>	 <p>Lubricant</p>
 <p>Security Torx</p>	 <p>GV-IP Speed Dome Software CD GV-NVR Software DVD</p>	<p>Terminal Block</p>