

GV-BX220D-2 / 220D-3 2MP H.264 D/N Box IP Camera



- 2 megapixel progressive scan CMOS
- Dual streams from H.264 and MJPEG
- Up to 30 fps at 1920 x 1080
- Built-in / external microphone
- 2-way audio
- One sensor input and alarm output
- TV-out support
- Built-in micro SD card slot (SD/SDHC) for local storage
- Wide Dynamic Range (WDR)
- Motion detection
- Tampering alarm
- Privacy mask
- IP address filtering
- DC 12V / PoE
- Removable IR-cut filter for Day/Night function
- Varifocal megapixel lens
- Supports iPhone, iPad, Android & 3GPP
- 31 languages on Web interface
- ONVIF (Profile S) conformant

* No Memory card slot & local storage function for Argentina.

Models

Models	Iris	Focal Length (mm)	Maximum Aperture	Image Format
GV-BX220D-2	DC Drive	2.8 ~ 6 mm	F/1.3	1/3"
GV-BX220D-3		2.8 ~ 12 mm	F/1.4	

Active Tampering Alarm

Tampered



Focus Change



Camera Shift



Dimensions

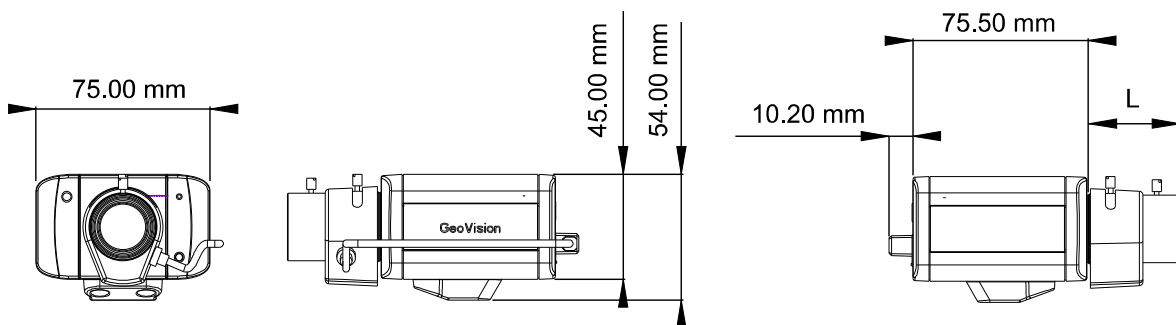

Specifications

		GV-BX220D-2	GV-BX220D-3
Camera			
Image Sensor		1/2.5" progressive scan CMOS	
Picture Elements		1920 (H) x 1080 (V)	
Minimum Illumination	Color	0.15 Lux	
	B/W	0.10 Lux	
	IR ON	0 Lux	
Shutter Speed		Automatic, Manual (1/5 ~ 1/8000 sec)	
White Balance		Automatic, Manual (2800K ~ 8500K)	
Gain Control		Automatic	
S/N Ratio		45 dB	
BLC		Yes	
Lens			
Megapixel		Yes	
Day/Night		Yes (with removable IR-cut filter)	
Lens Type		Varifocal	
Focal Length		2.8 ~ 6 mm	2.8 ~ 12 mm
Maximum Aperture		F / 1.3	F / 1.4
Mount		CS Mount	
Image Format		1/3"	
Operation	Focus	Manual (w / lock)	
	Zoom	Manual (w / lock)	
	Iris	DC drive	
Max. Torque (Focus/ Zoom Screws)		0.049 N.m	
Operation			
Video Compression		H.264, MJPEG	
Video Stream		Dual streams from H.264 and MJPEG	
Frame Rate		30 fps at 1920 x 1080 * The frame rate and the performance may vary depending on the number of connections and data bitrates (different scenes).	
Image Setting		Brightness, Contrast, Sharpness, Gamma, White Balance, Flicker-less, Image Orientation, Shutter Speed, D/N Sensitivity, Backlight Compensation, WDR, Defog	
Audio Compression		G.711, AAC (optional)	
Audio Support		Two-Way Audio	
Sensor Input		1 Input (Dry Contact)	
Alarm Output		1 Digital Output (200mA 5V DC)	
Video Resolution			
Main Stream	4:3	1600 x 1200, 1280 x 960, 640 x 480, 320 x 240	
	16:9	1920 x 1080, 1280 x 720, 640 x 360, 448 x 252	
	5:4	1280 x 1024, 640 x 512, 320 x 256	
Sub Stream	4:3	640 x 480, 320 x 240	
	16:9	640 x 360, 448 x 252	
	5:4	640 x 512, 320 x 256	
Network			
Interface		10/100 Ethernet	
Ethernet Protocol		HTTP, HTTPS, TCP, UDP, SMTP, FTP, DHCP, NTP, UPnP, DynDNS, 3GPP/ISMA, RTSP, PSIA, SNMP, QoS (DSCP), ONVIF (Profile S)	
Mechanical			
Connectors	Power	2-pin terminal block, PoE	
	Ethernet	RJ-45	
	Audio	1 In (Using the built-in microphone or externally connecting a microphone) 1 Out (Stereo phone jack, 3.5 mm / 0.14 in)	
	Digital I/O	3-pin terminal block, pitch 2.5 mm / 0.1 in	
	Auto Iris	DC drive	
	Local Storage	Micro SD card slot (SD/SDHC, SD version 2.0 only, Class 10) *SDXC and UHS-I card types are not supported.	
	TV-Out	BNC connector (640 x 480 resolution)	
LED Indicator		2 LEDs: Power, Status	



General	
Environment Temperature	0 °C ~ 50 °C / 32 °F ~ 122 °F
Humidity	10% to 90% (no condensation)
Power Source	12V DC / PoE
Max. Power Consumption	7 W
Regulatory	CE, FCC, C-Tick, RoHS compliant
Dimension (L X W X H)	75.5 x 75 x 54 mm / 3.05 x 2.95 x 2.13 in (without lens)
Weight	321 g / 0.71 lb
Power over Ethernet	
PoE Standard	IEEE 802.3af Power over Ethernet / PSE
PoE Power Supply Type	End-Span
PoE Power Output	Per Port 48V DC, 350mA. Max. 15.4 watts
Web Interface	
Installation Management	Web-based configuration
Maintenance	Firmware upgrade through Web Browser or Utility
Access from Web Browser	Camera Live View, Video Recording, Change Video Quality, Bandwidth Control, Image Snapshot, Digital I/O control, Audio, Picture in Picture, ,Picture and Picture, Privacy Mask, Visual Automation, Tampering Alarm, Text Overlay, Digital PTZ
Language	Arabic / Bulgarian / Czech / Danish / Dutch / English / Finnish / French / German / Greek / Hebrew / Hungarian / Indonesian / Italian / Japanese / Lithuanian / Norwegian / Persian / Polish / Portuguese / Romanian / Russian / Serbian / Simplified Chinese / Slovakian / Slovenian / Spanish / Swedish / Thai / Traditional Chinese / Turkish
Applications	
Network Storage	GV-NVR, GV-System, GV-Backup Center, GV-Recording Server
Smart Device Access	GV-Eye for Android smartphone, tablet, iPhone, and iPod Touch GV-Eye HD for iPad
Live Viewing	IE, mobile phone
CMS Server support	GV-Control Center, GV-Center V2, GV-VSM





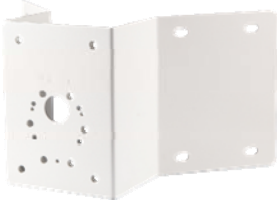

Note: Specifications are subject to change without notice.

Packing List

- | | |
|--|-------------------------------------|
| 1. Box Camera | 6. Camera Holder |
| 2. Terminal Block | 7. GV-IPCAM H.264 Quick Start Guide |
| 3. Fixed Focal or Varifocal Megapixel Lens | 8. GV-IPCAM H.264 Software CD |
| 4. Six Lens Rings | 9. GV-NVR Quick Start Guide |
| 5. Video Out Wire | 10. GV-NVR Software DVD |

Accessories

Model No.	Name	Details
	Convex Corner Adapter Kit	
GV-Mount300		Dimensions: 238.6 x 409.5 mm (9.4" x 16.1") Weight: 4.27 Kg (9.41 lb)
	Concave Corner Adapter Kit	
GV-Mount310		Dimensions: 123.3 x 393.1 mm (4.9" x 15.5") Weight: 2.96 Kg (6.53 lb)

Model No.	Name	Details
	Pole Mount Bracket Kit (Ø 4" ~ 6")	
GV-Mount400		Dimensions Bracket: 241 x 161 mm (9.5" x 6.3") Weight: 1.70 Kg (3.75 lb) Steel Strap Diameter: Ø 4" ~ 6"
	Pole Mount Bracket Kit (Ø 6" ~ 7.5")	
GV-Mount410		Dimensions Bracket: 241 x 161 mm (9.5" x 6.3") Weight: 1.70 Kg (3.75 lb) Steel Strap Diameter: Ø 6" ~ 7.5"
	Housing Box (with heater and fan)	
GV-Housing101	 IP67 IK10	Dimensions: 406 x 145 x 109 mm (16 x 5.7 x 4.3") Weight: 4.69 Kg (10.34 lbs) (including Supporting Tube) Start-up Temperature: -30°C ~ 50°C (-22°F ~ 122°F) Operation Temperature: -40°C ~ 50°C (-40°F ~ 122°F) Heater: 15°C (59°F) On / 25°C (77°F) Off Fan: 35°C (95°F) On / 25°C (77°F) Off Power board: 24V AC or 12V DC input
GV-IR LED T2		Weight: 140 g / 0.31 lbs Dimensions (H x W x D): 49 x 47 x 67 mm / 1.93 x 1.85 x 2.64 in
GV-PA191 PoE Adapter		Weight: 130 g / 0.29 lb Dimensions (H x W x D): 43 x 69 x 40 mm / 1.69 x 2.72 x 1.57 in
GV-Relay V2		The GV-Relay V2 is designed to expand the voltage load of GV IP devices. It provides 4 relay outputs, and each can be set as normally open (NO) or normally closed (NC) independently as per your requirement.
Power Adapter		Power adapters are available in 4 regions: U.S.A., Australia, U.K and Europe.
GV-POE Switch		The GV-POE Switch is designed to provide power along with network connection for IP devices. The GV-POE Switch is available in various models with different numbers and types of ports.