



# GV-Keyboard V3

---

*User's Manual*



Before attempting to connect or operate this product,  
please read these instructions carefully and save this manual for future use.



© 2010 GeoVision, Inc. All rights reserved.

Under the copyright laws, this manual may not be copied, in whole or in part, without the written consent of GeoVision.

Every effort has been made to ensure that the information in this manual is accurate. GeoVision, Inc. makes no expressed or implied warranty of any kind and assumes no responsibility for errors or omissions. No liability is assumed for incidental or consequential damages arising from the use of the information or products contained herein. Features and specifications are subject to change without notice.

GeoVision, Inc.  
9F, No. 246, Sec. 1, Neihu Rd.,  
Neihu District, Taipei, Taiwan  
Tel: +886-2-8797-8377  
Fax: +886-2-8797-8335  
<http://www.geovision.com.tw>

Trademarks used in this manual: *GeoVision*, the *GeoVision* logo and *GV* series products are trademarks of GeoVision, Inc. *Windows* and *Windows XP* are registered trademarks of Microsoft Corporation.

July 2010

# Contents

Regulatory Notices .....	1
Naming and Definition .....	2
1. Introduction .....	3
1.1 Packing List .....	4
1.2 System Requirements .....	4
1.3 Password Protected Feature .....	4
2. Overview .....	5
2.1 Keyboard Overview .....	5
3. PTZ Camera Installation and Setup.....	9
3.1 Installing PTZ Cameras .....	10
3.2 Setting up PTZ Cameras .....	11
3.3 Wall Terminal Block .....	12
4. Connection to the GV-System .....	13
4.1 Connecting to One GV-System .....	13
4.2 Connecting to Multiple GV-Systems .....	14
4.3 Installing USB Driver .....	15
4.4 Starting the Keyboard Application.....	17
4.4.1 Defining Eight Function Keys .....	19
4.4.2 Printing Function Key Labels.....	20
4.5 Using the Keyboard for Login .....	21
4.6 Using the Keyboard with Multiple Monitors .....	22
4.6.1 Non-Monopoly Mode .....	23
4.6.2 Monopoly Mode.....	25
5. Programming and Operation .....	28
6. On-Screen Display Menus.....	30
6.1 The OSD Menu in Main System.....	30
6.1.1 Changing the Main System OSD Options .....	31
6.2 The OSD Menu in ViewLog .....	32
6.2.1 Changing the ViewLog OSD Options .....	32
7. Shortcut Key Conflict Test.....	33

8. Troubleshooting .....	34
Specifications .....	35
Appendix .....	36

## Regulatory Notices



### FCC Notice

This equipment has been tested and found to comply with the limits for a Class A digital device, pursuant to part 15 of the FCC Rules. These limits are designed to provide reasonable protection against harmful interference when the equipment is operated in a commercial environment.

### Class A

This equipment generates, uses, and can radiate radio frequency energy and, if not installed and used in accordance with the instruction manual, may cause harmful interference to radio communications. Operation of this equipment in a residential area is likely to cause harmful interference in which case the user will be required to correct the interference at their own expense.



### CE Notice

This is a Class A product. In a domestic environment, this product may cause radio interference in which case the user may be required to take adequate measures.

### RoHS RoHS Compliance

The Restriction of Hazardous Substances (RoHS) Directive is to forbid the use of hazardous materials of production. To meet the RoHS Directive requirements, this product is made to be RoHS compliant.



### WEEE Compliance

This product is subject to the Waste Electrical and Electronic Equipment (WEEE) Directive and made compliant with the WEEE requirements.

## Naming and Definition

<b>GV-System</b>	GeoVision Analog and Digital Video Recording Software. The GV-System also refers to <b>GV-Multicam System</b> , <b>GV-NVR System</b> , <b>GV-DVR System</b> and <b>GV-Hybrid DVR System</b> at the same time.
------------------	---

# 1. Introduction

The GV-Keyboard V3 is used to program and operate GV-Systems and PTZ cameras. Through RS-485 configuration, it can control up to 16 GV-Systems. In addition, through RS-485 or RS-422 connection, it can set up and control up to 32 PTZ cameras directly without making any configuration through the GV-System.

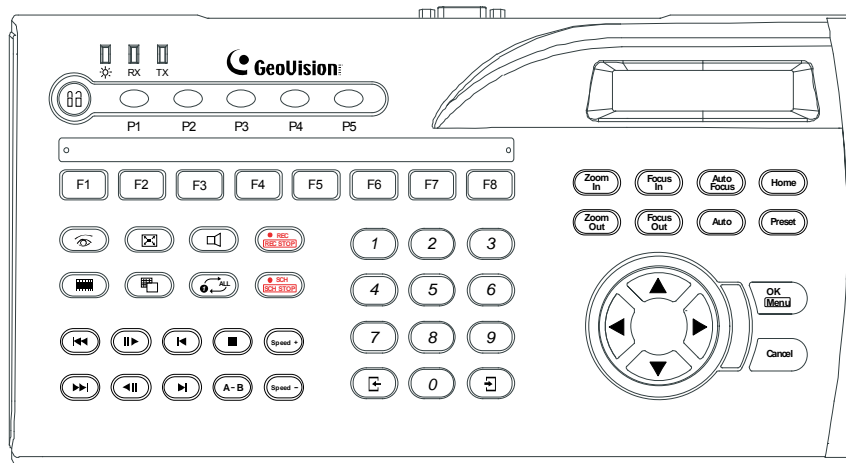

## Key Features

- Control up to 16 GV-Systems
- Directly set up and control up to 32 PTZ cameras
- OSD panel supported

---

### Important:

GV-Keyboard V3 allows you to set up and control PTZ cameras directly without going through GV-Systems. To see the list of PTZ camera protocol supported for this new feature, see *Supported PTZ Protocols and Brands, Appendix*.

GV-Keyboard V3 also supports controlling the PTZ cameras connected to GV-Systems. For the PTZ cameras supported by GV-Systems, see *Supported PTZ Protocol and Model, Appendix, DVR User's Manual on the Surveillance System Software DVD*.

---

## 1.1 Packing List

- GV-Keyboard V3 x 1
- Power Adaptor (DC Output 12V, 1A) x 1
- USB Cable x 1
- RJ-11 Cable x 1
- Wall Terminal Block x 1
- GV-Keyboard V3 Software CD x 1

## 1.2 System Requirements

- Windows XP / Vista / 7 / Server 2008

---

**Note:** Currently, GV-Keyboard V3 does not support embedded operating systems.

---

## 1.3 Password Protected Feature

The GV-Keyboard V3 is protected with a password. When you use the Keyboard for the first time, you will need to enter the default password "0000" to unlock it. You can set an auto lock time to lock the GV-Keyboard V3 after an idle period. The GV-Keyboard V3 can be unlocked only when you enter the correct password. The default auto lock time is 00, which means the auto lock function is disabled by default. To change the default password and the auto lock time, see "Changing password" and "Setting auto-lock period", 5. *Programming and Operation*.



## 2. Overview

### 2.1 Keyboard Overview

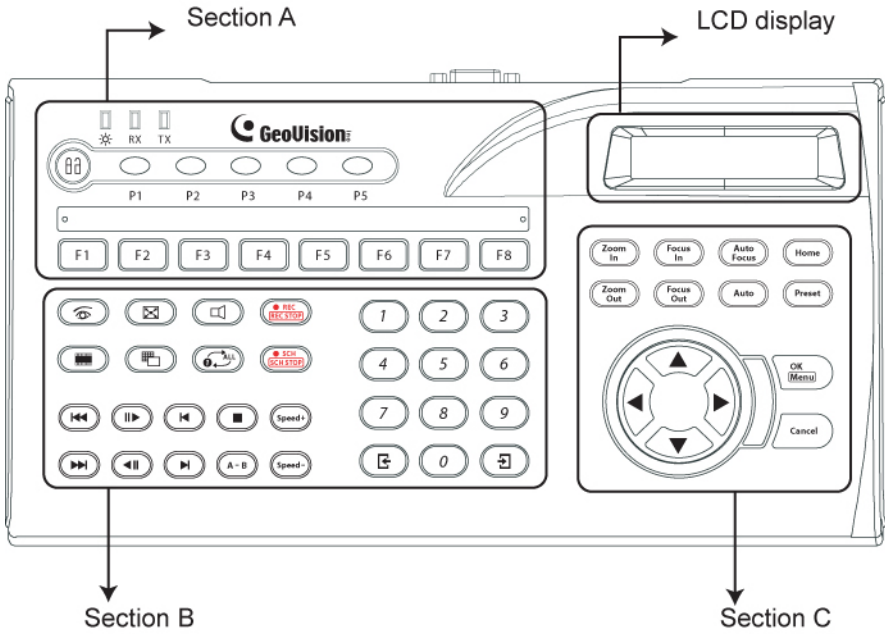

Figure 1

- Section A

- Yellow POWER LED.
- RX** Red RX LED (Receive).
- TX** Green TX LED (Transmit).
- P1** Changes DVR ID.
- P2** Select a PTZ camera to control.
- P3** Configures the Keyboard parameters, including password, key beep and auto-lock period.
- P4** Sets up the PTZ camera settings.
- P5** Displays the firmware version.
- Locks the Keyboard.
- F1-8** Function keys.

● Section B



Launches Multicam Surveillance System (Main System).

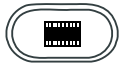

Launches ViewLog.



Turns full screen view on/off.

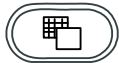

Switches the screen divisions.



Turns the sound on/off.



Plays next events automatically.



Starts/Stops recording.



Starts/Stops the scheduled recording.



Goes to the previous event.



Goes to the next event.



Plays/Pauses a video event.



Rewinds/Pauses a video event.



Moves one frame back.



Moves one frame forward.



Stops a video event.



Sets the starting and ending frames for auto playing.

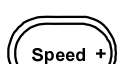

Increases playback speed.



Decreases playback speed.



Switches to the previous screen.



Switches to the next screen.

**Numeric buttons**

Enters the login password; Selects a specific camera; Changes the Time Setting in ViewLog.

● **Section C**



Zooms in the display image of PTZ camera in Main System; Zooms in the display image in ViewLog.



Zooms out the display image of PTZ camera in Main System; Zooms out the display image in ViewLog.



Increases the focus of PTZ camera in Main System.

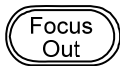

Decreases the focus of PTZ camera in Main System.



Auto Focus.



Sets the PTZ camera for auto mode.



Moves the PTZ camera to the default position.



Moves the PTZ camera to a preset location.



Calls up the Login dialog box; Enters the settings; Opens the OSD menu.



Closes the OSD menu; Returns to the previous menu; Calls up the menu to exit Main System or ViewLog.

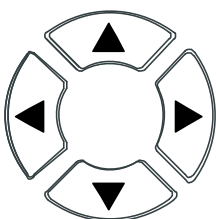

PTZ control; Navigates the display image in ViewLog; Navigates the OSD menu; Changes the Time Setting in ViewLog.

## 2.1 Rear Panel Overview

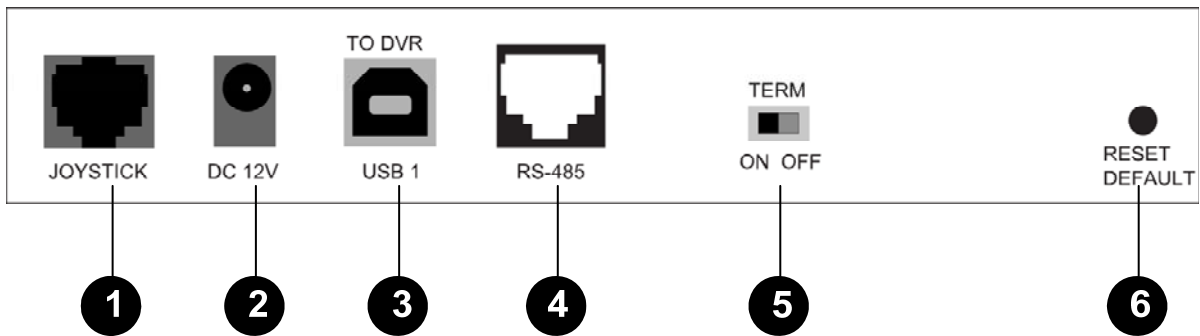

**Figure 2**

No	Name	Function
1	Joystick	Connects to GV-Joystick for PTZ control.
2	DC 12V	Connects to the power adaptor.
3	USB1 Port	Connects to one GV-System.
4	RS-485 Port (RJ-11)	Through the supplied Wall Terminal Block, the RS-485 port can connect to: <ul style="list-style-type: none"> <li>• up to 16 GV-Systems by using the assigned RS-485 pins.</li> <li>• up to 32 PTZ cameras by using the assigned RS-485 or RS-422 pins.</li> </ul> For details on the pin assignments on the Wall Terminal Block, see <i>3.3 Wall Terminal Block</i> .
5	Terminal Resistance	Used in the last daisy-chained GV-System.
6	Reset	Resets the Keyboard when it does not respond to commands.

### 3. PTZ Camera Installation and Setup

You can connect up to 32 PTZ cameras to the GV-Keyboard V3 directly without going through the GV-System. You can directly control the PTZ cameras by using the PTZ control keys on the Keyboard. For supported PTZ protocols and brands, see *Supported PTZ Protocols and Brands, Appendix*.

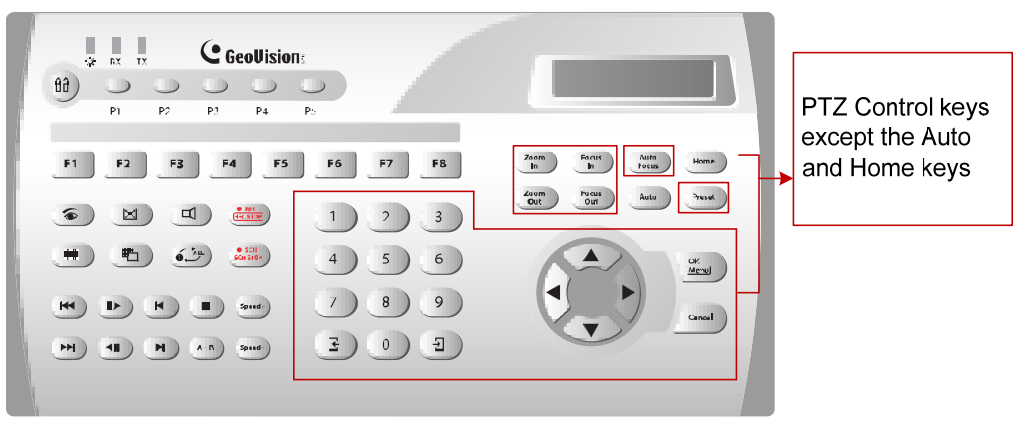

Figure 3

### 3.1 Installing PTZ Cameras

You can connect up to 32 PTZ cameras together, through either a single RS-485 or RS-422 cable, to the GV-Keyboard V3. Choosing between RS-485 and RS-422 is depended on the PTZ camera being used. See the illustration below for connections.

Items required for connections:

- Supplied RJ-11 Cable
- Supplied Wall Terminal Block
- Supplied Power Adaptor

For RS-485 connection, use Pin-1 and Pin-5 on the Wall Terminal Block to connect the PTZ camera. For RS-422 connection, use Pin-3 and Pin-4 on the Wall Terminal Block to connect the PTZ camera. For details on the pin assignments on the Wall Terminal Block, see 3.3 *Wall Terminal Block*.

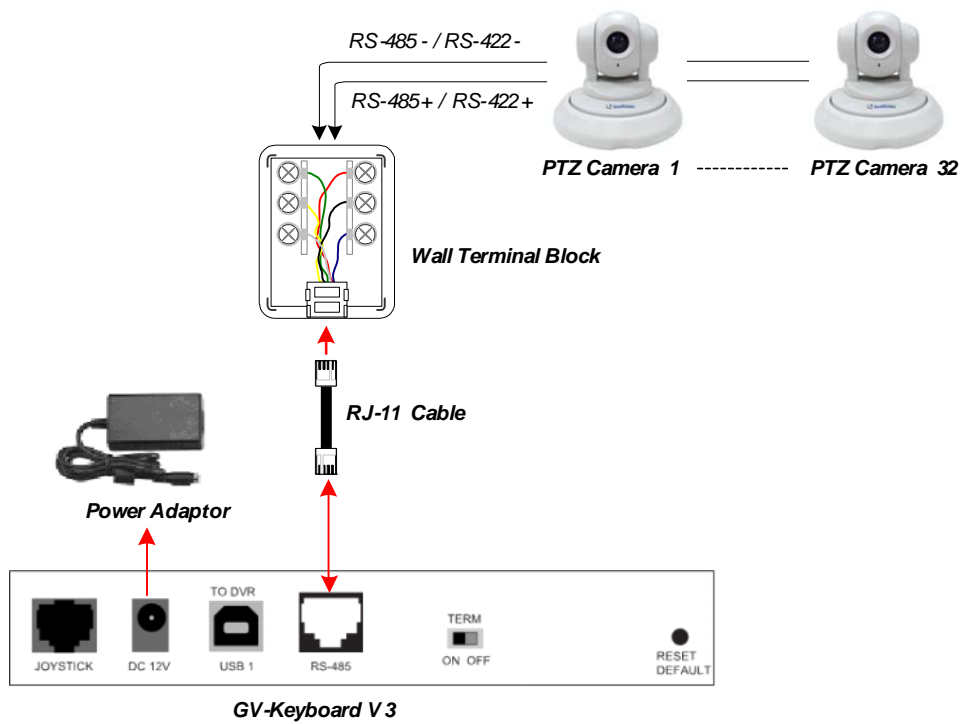

**Figure 4**

## 3.2 Setting up PTZ Cameras











After PTZ camera installation, you have to set up the camera's number, type, baud rate and PTZ ID through the GV-Keyboard V3.

When multiple PTZ cameras are connected together, you need to configure each camera's address. Read the manual of the PTZ camera you purchased for address setup. Remember each camera's address because they will be the camera's ID (PTZ ID) in the following software setup. The PTZ camera's ID is necessary for the GV-Keyboard V3 to distinguish one camera from another.

Follow the steps below to set up PTZ cameras through the GV-Keyboard V3. You can see the settings on the LCD display of the GV-Keyboard V3.



**Figure 5**

1. Press , and type the default password "0000" to unlock the GV-Keyboard V3.
2. Press **P4**, and press  to select a PTZ camera number, and press .
3. Press  to set up a **PTZ Type**, and press . For details on the PTZ protocols, see *Supported PTZ Protocols and Brands, Appendix* later in this manual.
4. Press  to set up the **Baud rate**, and press .
5. Press  to set up the **PTZ ID**, and press .
6. After the above settings, you can press **P2** and press  to select a PTZ camera number that you want to control through the GV-Keyboard V3. Alternatively, you can press **P2** and press the number keys to select a camera, for example, pressing 0 and then 1 for Camera No. 1.

### 3.3 Wall Terminal Block

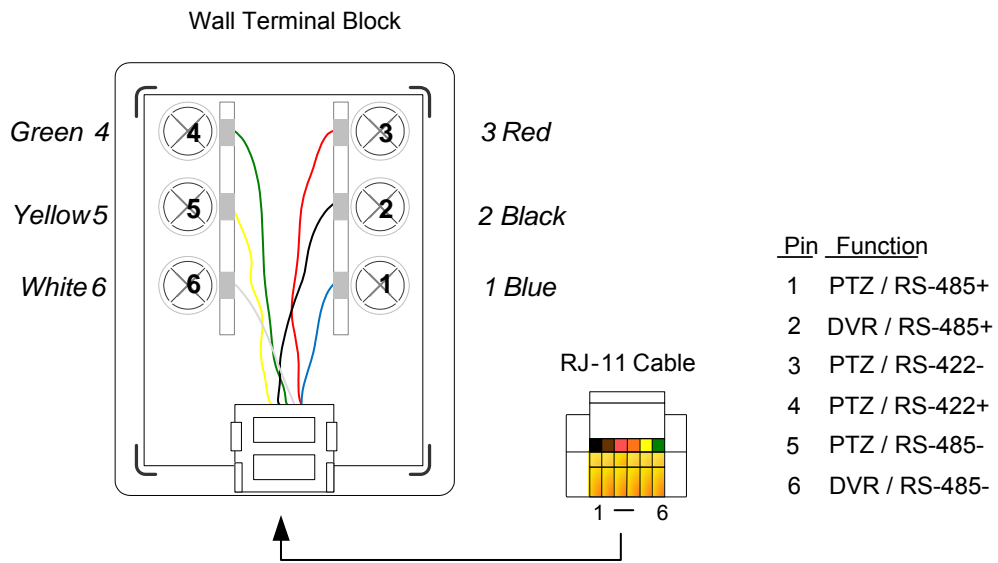

**Figure 6**

---

**Note:** Each pin is assigned to its corresponding cable of the unit. To connect the PTZ camera, use Pin-1 and Pin-5 (for RS-485 connection) or Pin-3 and Pin-4 (for RS-422 connection). To connect the GV-System, use Pin-2 and Pin-6.

---



## 4. Connection to the GV-System

You can connect the GV-Keyboard V3 to one GV-System by using the supplied USB cable or up to 16 GV-Systems through the RS-485 pins on the Wall Terminal Block.

### 4.1 Connecting to One GV-System

To connect GV-Keyboard V3 to one GV-System, use the USB1 port on the GV-Keyboard V3. See the illustration below for connection.

Item required for connection:

- Supplied USB Cable

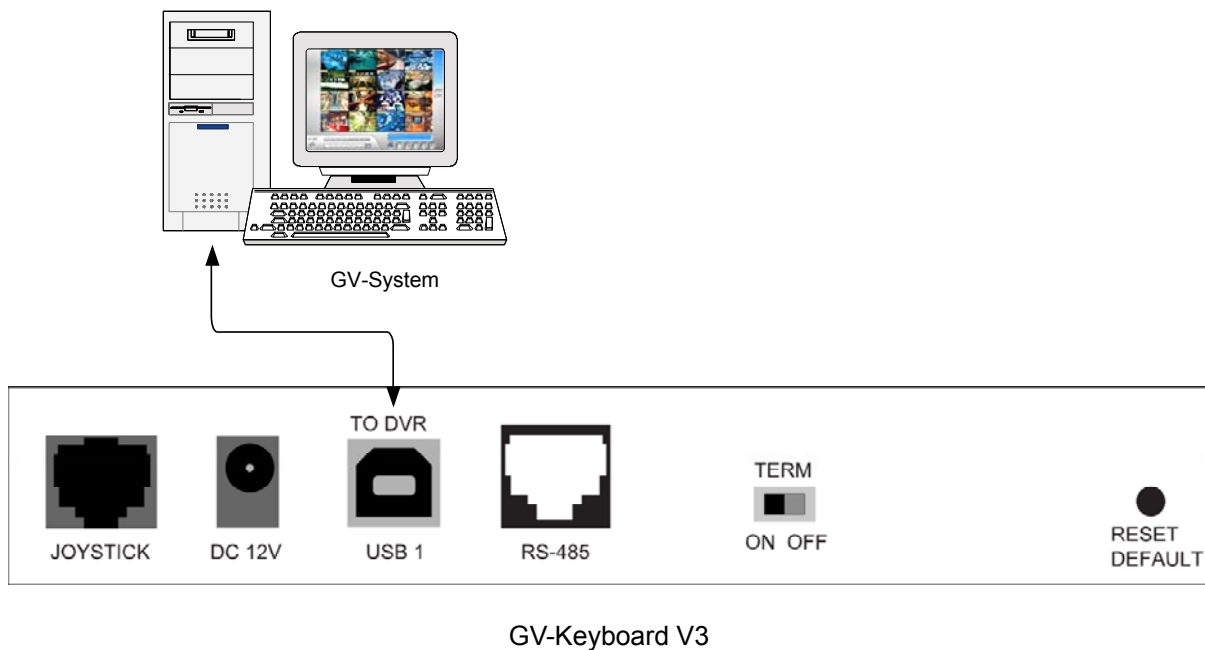

**Figure 7**

---

**Note:** When using the USB cable to connect between the GV-Keyboard V3 and GV-System, you don't have to connect the GV-Keyboard V3 to a power supply.

---

## 4.2 Connecting to Multiple GV-Systems

To connect the GV-Keyboard V3 to up to 16 GV-Systems, use the RS-485 port on the GV-Keyboard V3. See the illustration below for connections.

Items required for connections:

- Supplied RJ-11 Cable
- Supplied Wall Terminal Block
- Supplied Power Adaptor
- RS-485 / RS-232 interface converter, e.g. GV-NET Card, GV-NET/IO Card, GV-Hub and GV-COM.

Connect one end of the RJ-11 cable to the RS-485 port on the GV-Keyboard V3 and the other end to the Wall Terminal Block. Then connect the Wall Terminal Block to the RS-485 / RS-232 interface converter. For details on the pin assignments on the Wall Terminal Block, see 3.3 *Wall Terminal Block*.

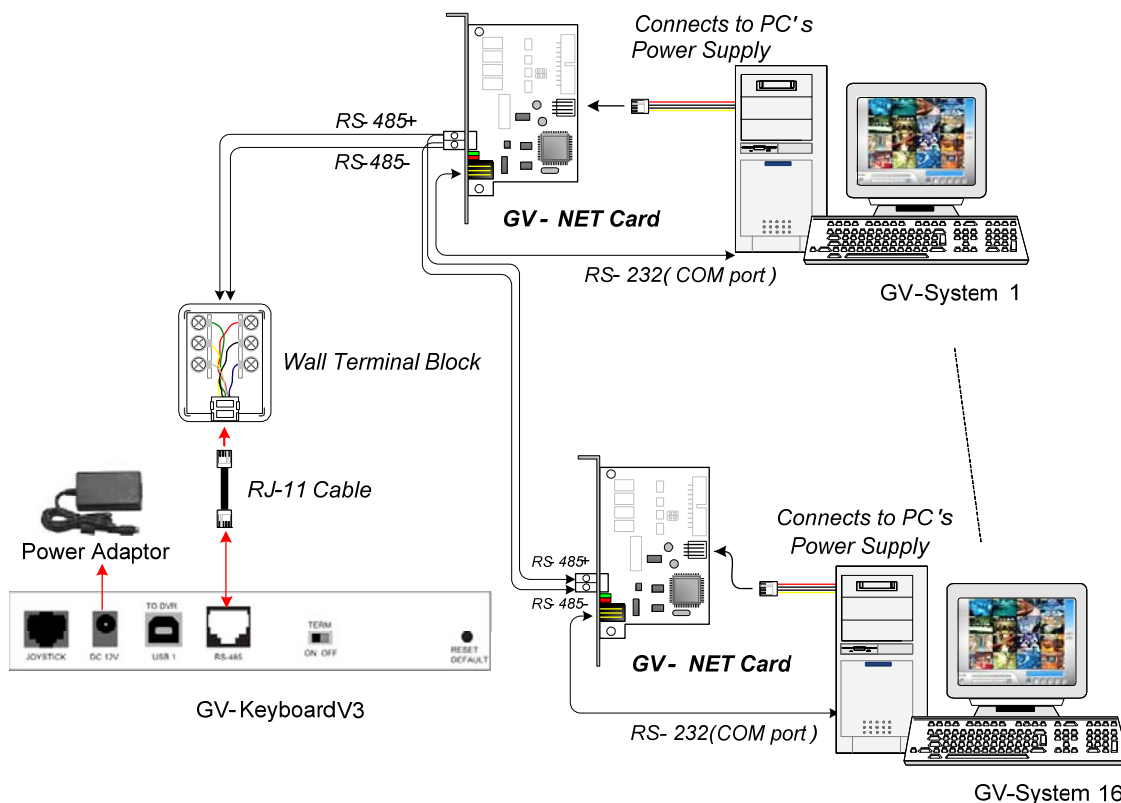

**Figure 8**

**Note:** Because GV-Keyboard V3 uses RS-485 communication that has a distance limitation, the total distance between the GV-Keyboard V3 and the GV-Systems needs to be within 600 meters (1968.5 feet).

### 4.3 Installing USB Driver

If you use the USB port to connect the GV-Keyboard V3 to the GV-System, it is necessary to install the USB driver. After you use the USB cable to connect the GV-Keyboard V3 to the GV-System, the Found New Hardware Wizard will automatically detect the device. Ignore the Wizard and follow these steps to install the driver:

---

**Note:** You can only install the drivers by using the attached Software CD, or the Software DVD of GV-System V8.4 or later.

---

1. Insert the Software CD. This window pops up.



*Figure 9*

2. Select **Install Geovision USB Devices Driver**. This dialog box appears.

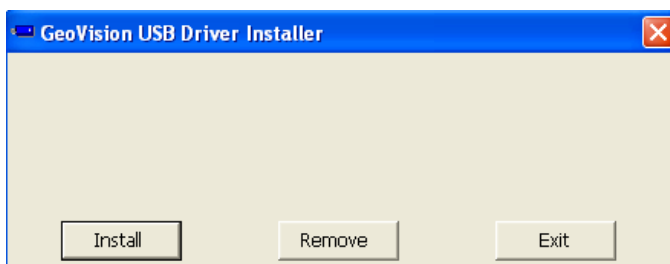

*Figure 10*

3. Click **Install** to install the driver. When the installation is complete, this message will appear: *Install done!*
4. Click **Exit** to close the dialog box.
5. To verify that the driver is installed correctly, go to Windows Device Manager. In the Ports (COM & LPT) field, you should see the entry for **STM Virtual COM Port**.

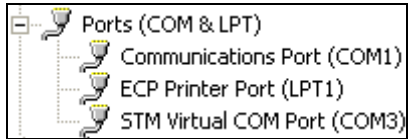

**Figure 11**

---

**Note:** Remember the COM port showing in the **STM Virtual COM Port** entry. It indicates the port number that the keyboard is using.

---

## 4.4 Starting the Keyboard Application

When using the GV-Keyboard V3 to control the GV-System, you need to run the following program in the background.

1. Run **mcamctrl.exe** from the GV folder.

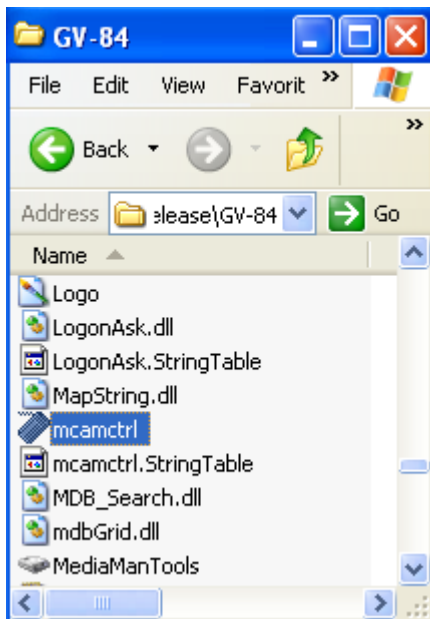

**Figure 12**

2. The Keyboard & Joystick controller dialog box appears.

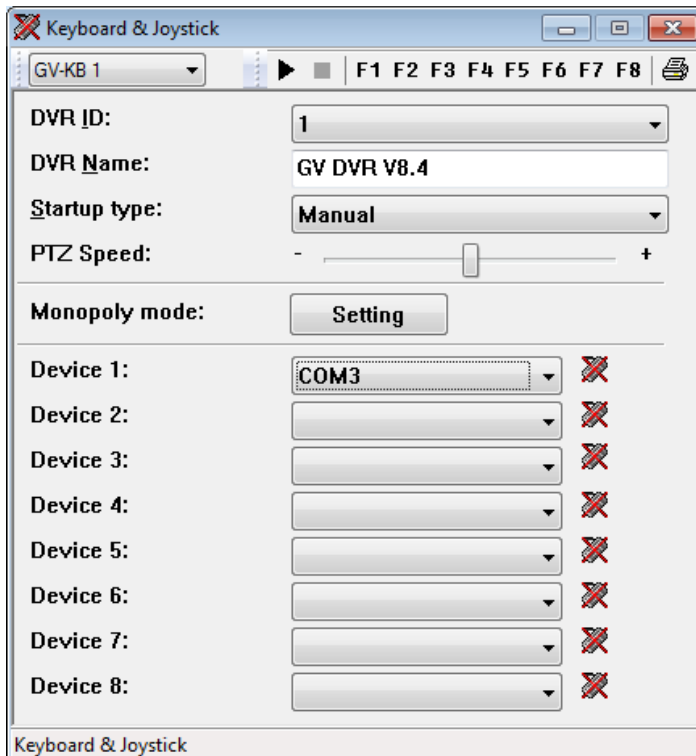

**Figure 13**

3. In the **Device** drop-down list, select the COM port that the GV-Keyboard V3 is connected to. The COM port number can be found in the Windows Device Manager (Figure 11).
4. Click ►. You can start to control the GV-System by using the GV-Keyboard V3 now.

The controls in the Keyboard & Joystick controller dialog box:

Name	Description
DVR ID	Select the desired DVR ID for connection.
DVR Name	Gives the DVR a descriptive name.
Startup type	Select Manual or Automatic to choose whether to run the controller at next startup or not.
PTZ Speed	Adjusts PTZ speed.
Monopoly Mode	Assign the Keyboard to control a specific monitor and set up the control mode
Device 1-8	Select the COM port connecting to the Keyboard. Find the COM port number the Keyboard is using in the Ports field of Windows Device Manager. See Step 5 of <i>4.3 Installing USB Driver</i> .
GV-KB 1 ▼	Select the Keyboard to define F1-F8 functions.
►	Starts the service.
■	Stops the service.
F1 - F8	Defines eight function keys on the Keyboard to control output modules, display layout, PTZs, cameras and etc.
	Prints out a label for the eight function keys.

---

**Note:** You can connect up to 8 units of GV-Keyboard V3 to one GV-System. When multiple units of GV-Keyboard V3 are connected, be sure to verify the driver installation of each GV-Keyboard V3 in the Ports field of Windows Device Manager. If the driver of any device is not installed properly, select **Install or Remove GeoVision GV-Series Driver** on the Software DVD to re-install it. After selecting the COM port that each GV-Keyboard V3 is connected to, you can start to use the drop-down list  at upper left corner to select a device to configure.

---

### 4.4.1 Defining Eight Function Keys

F1 - F8 options allow you to assign these features to the eight function keys on the Keyboard:

- Output Control
- Display Layout
- PTZ Preset Go
- PTZ Auto
- Camera Select
- Start/Stop Camera Scan
- Matrix Switch
- Digital Matrix
- Spot Monitor
- TV Quad

---

**Note:** For the PTZ Preset Go and PTZ Auto functions, you must map the PTZ camera first in the GV-System.

---

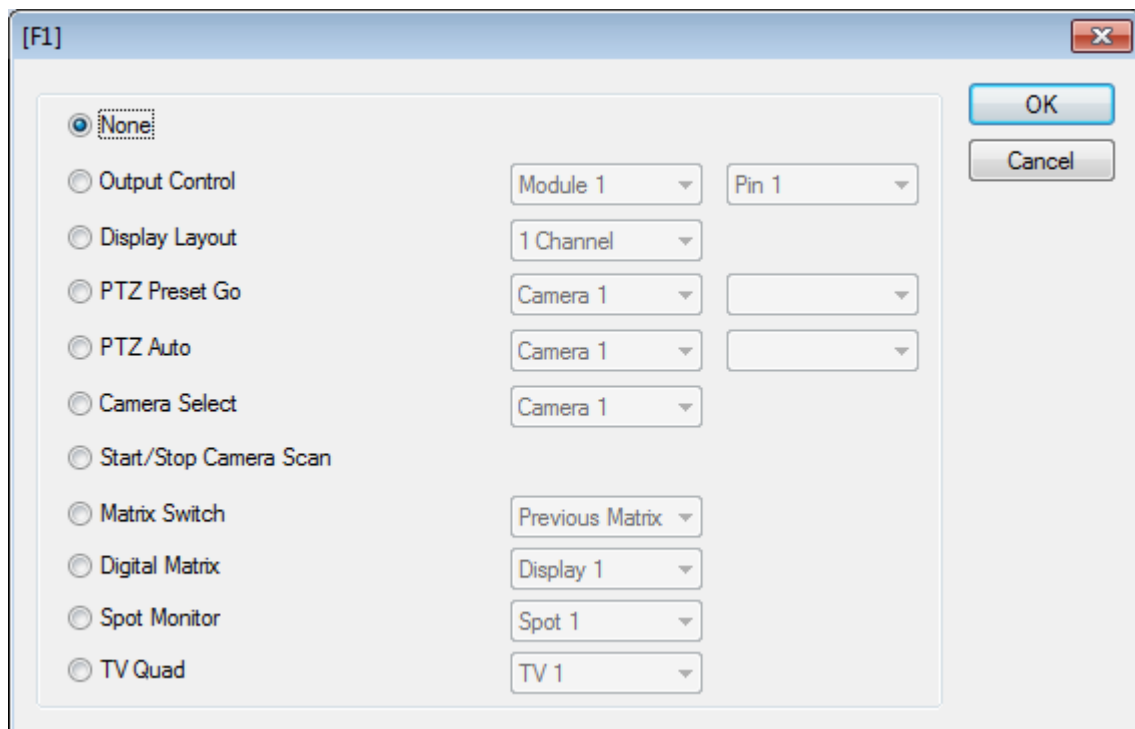
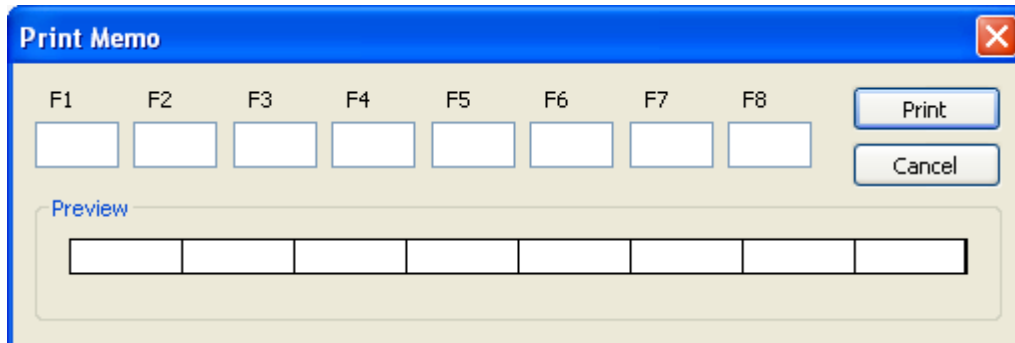

**Figure 14**

## 4.4.2 Printing Function Key Labels

The Print Memo option allows you to print out the labels for the eight function keys (F1 - F8) so that you can paste them on the Keyboard for instant reference.

1. Click the **Printer** icon. This displays the Printer Memo dialog box.
2. Under every field from F1 to F8, type the information that you want to print on the labels. The words you type will also appear on Preview fields for print preview.
3. Click **Print**.



The image shows a dialog box titled "Print Memo" with a blue header and a red close button. It contains eight input fields labeled F1 through F8. To the right of these fields are "Print" and "Cancel" buttons. Below the input fields is a "Preview" section with a horizontal bar divided into eight segments, corresponding to the F1-F8 fields.

*Figure 15*



## 4.5 Using the Keyboard for Login

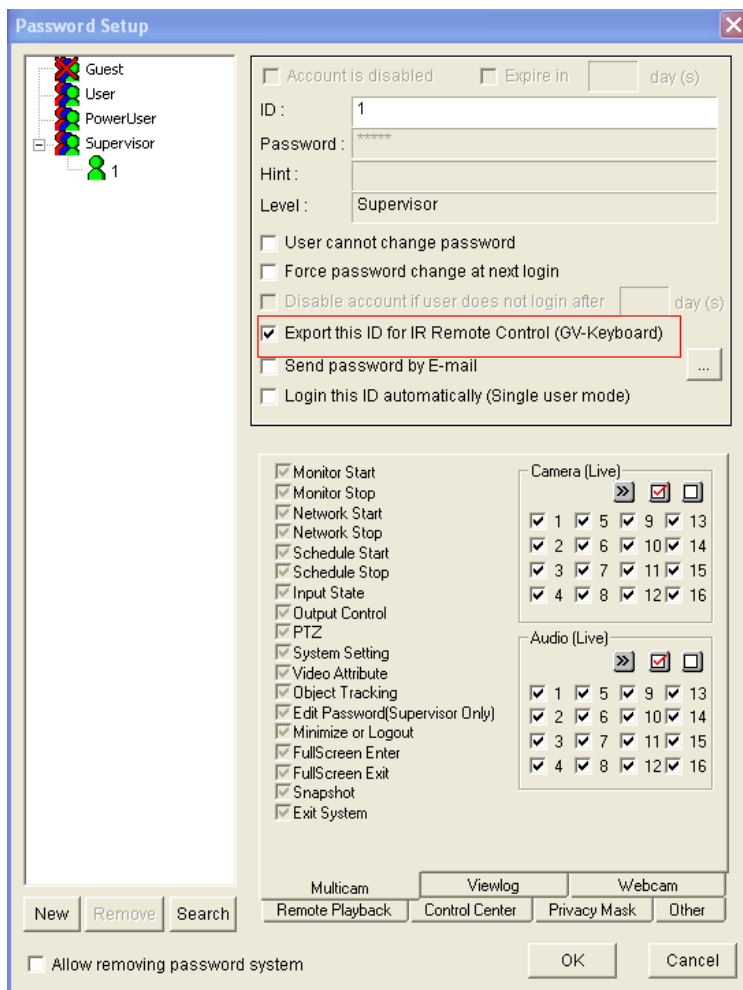

If you want to use the GV-Keyboard V3 to log into the GV-System instead of using the general keyboard and mouse, you must export the login ID and password from the GV-System first. Note the IDs and passwords configured can ONLY be composed of digits.

1. Click the **Configure** button, select **General Setting**, select **Password Setup** and select **Local Account Edit**. The Password Setup dialog box appears.



**Figure 16**

2. Select a user from the user list, and select **Export this ID for IR Remote Control (GV-Keyboard)** to export the ID and Password to the Login dialog box. Click **OK**.

After you complete the above setting, you can start to use the GV-Keyboard V3 to log into the GV-System. Click  to log into the GV-System. You will see the exported ID in the ID drop-down list of the Login dialog box. Click  to select the user's ID. Type the password and click .

## 4.6 Using the Keyboard with Multiple Monitors

You can use the GV-Keyboard V3 to control additional TV or spot monitors which are set up to display pop-up alert and page scan by using **Digital Matrix**, **Spot Monitor** or **Quad Spot Monitor** (TV Quad) function.

The GV-Keyboard V3 helps you quickly switch control between multiple monitors if any of them displays an event that catches your attention through pop-up alert or page scan.

There are two modes for the GV-Keyboard V3 applications with multiple monitors:

### Non-Monopoly Mode

In this mode, one GV-Keyboard V3 can control up to 8 monitors, or up to 8 units of GV-Keyboard V3 can work with up to 8 monitors together. Because multiple keyboards may interfere with each other on the same monitor or the GV-System, it is suggested to apply this mode when the GV-System and additional monitors are placed close to each other.

### Monopoly Mode

In this mode, each GV-Keyboard V3 or GV-Joystick can only control one assigned monitor. This mode can prevent multiple devices from interfering with each other on the GV-System; therefore it is suggested to apply this mode when the GV-System and additional monitors are placed at separate places with different operators.

### 4.6.1 Non-Monopoly Mode

In the Non-Monopoly mode, you can switch control between GV-System and additional monitors by pressing a defined **Function Key** on the GV-Keyboard V3. Up to 8 units of GV-Keyboard V3 can connect to one GV-System, and therefore you may define Function Keys on each GV-Keyboard V3 to quickly access additional monitors.

It is required to run **mcamctrl.exe** in the background when you use the GV-Keyboard V3 for screen display control.

1. Run **mcamctrl.exe** from GV folder. The Keyboard & Joystick controller dialog box appears (Figure 13).
2. In the Device field, select the COM port connecting to each GV-Keyboard V3. The COM port number can be found in Windows Device Manager (Figure 11).
3. Use the drop-down list  at upper left corner to select a device to be configured.
4. Click a **Function Key** to set up quick access to an additional monitor. This dialog box appears.

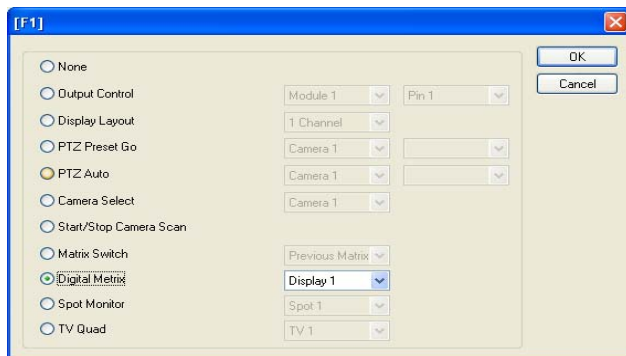

**Figure 17**

5. Select **Digital Matrix**, **Spot Monitor**, or **TV Quad** according to your configuration for that monitor.
6. Select a specific monitor number for quick access.
7. Repeat Step 3 to 6 to configure another GV-Keyboard V3.

---

#### Note:

1. When multiple units of GV-Keyboard V3 or GV-Joysticks are connected, be sure to verify the driver installation of each GV-Keyboard V3 or GV-Joystick in the Ports field of Windows Device Manager. If the driver of any device is not installed properly, select **Install or Remove GeoVision GV-Series Driver** on the Software DVD to re-install it.
  2. Function Keys are not available on GV-Joystick; therefore the Non-Monopoly mode is only for GV-Keyboard V3.
-

### Controlling Screen Display on Additional Monitors

The following picture illustrates the keys of the GV-Keyboard V3 that you can use for screen display control on additional monitors.

To resume the earlier screen display after pressing a **Function Key** to access the additional monitor, press the same function key again.

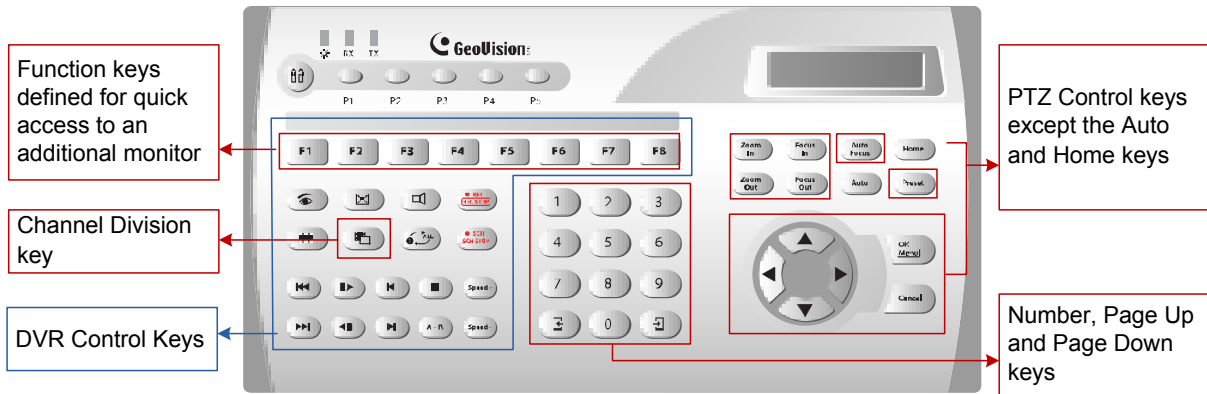

Figure 18

---

**Note:** The PTZ control only works in Single View.

---

### 4.6.2 Monopoly Mode

In Monopoly Mode, each GV-Keyboard V3 or GV-Joystick can only control one assigned monitor. This mode is recommended when multiple monitors are placed at separate locations.

The diagram below illustrates the wiring of 8 units of the combination of GV-Keyboard V3 and GV-Joystick. Because of the long distance additional monitors may cover, use RS-485 cables to connect each GV-Keyboard V3 to RS-485 converters (e.g. GV-Hub and GV-COM) and then connect these RS-485 converters to the GV-System through USB port.

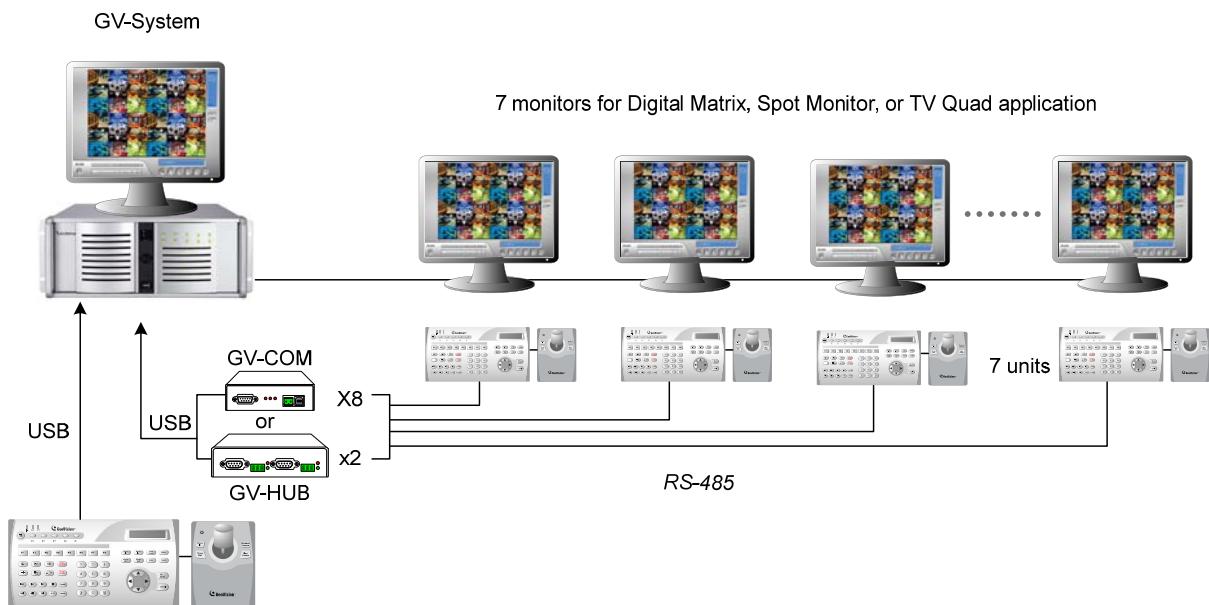

Figure 19

#### Assigning a GV-Keyboard V3 or GV-Joystick to an Additional Monitor

1. Repeat Steps 1 to 3 in Non-Monopoly Mode mentioned earlier.
2. Click the **Setting** button of Monopoly Mode.

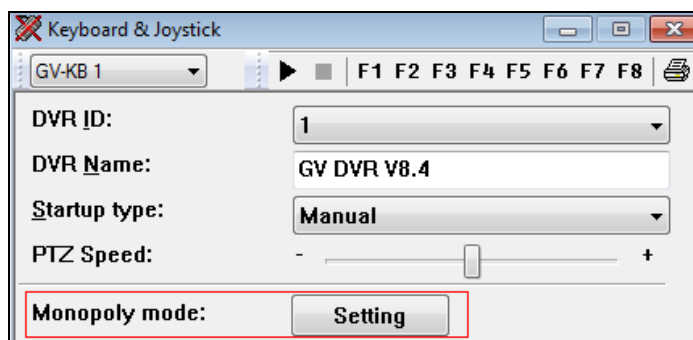
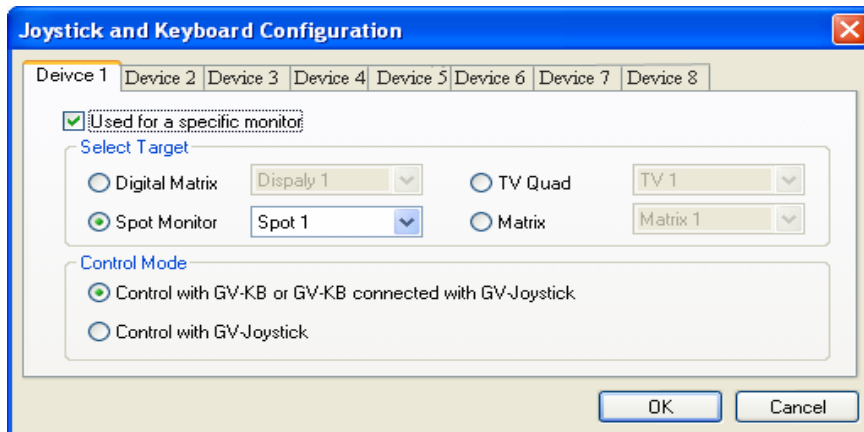

Figure 20

3. Select the **Device** tab for the GV-Keyboard V3 that you want to assign a monitor for.



*Figure 21*

4. Select **Used for a specific monitor**.
5. Under **Select Target** section, select **Digital Matrix**, **Spot Monitor**, **TV Quad** or **Matrix** according to the configuration of that monitor, and select the specific monitor number from the drop-down list.
6. Under **Control Mode** section, select between using GV-Keyboard V3 alone or with GV-Joystick (**Control with GV-KB or GV-KB connected with GV-Joystick**) and using GV-Joystick alone (**Control with GV-Joystick**).

### Controlling Screen Display on Additional Monitors

- For users of GV-Joystick only:

Press **Previous Camera** or **Next Camera** to select and control a PTZ camera on the additional monitor. To return to the previous screen display such as a pop-up alert or page scan, keep pressing **Previous Camera** until reaching the camera prior to the first PTZ camera or **Next Camera** until reaching the camera after the last PTZ camera.

- For users of GV-Keyboard V3 or GV-Keyboard V3 with GV-Joystick:

Press **Switch Channel Division** , **Previous Screen** , **Next Screen**



or enter the desired camera number to control the assigned camera (Press **Previous Camera** or **Next Camera** on the GV-Joystick to get the same effect). Press **Cancel** to return to the previous screen display such as a pop-up alert or page scan.

The following picture illustrates the keys of the keyboard that you can use for screen display control in the Monopoly Mode.

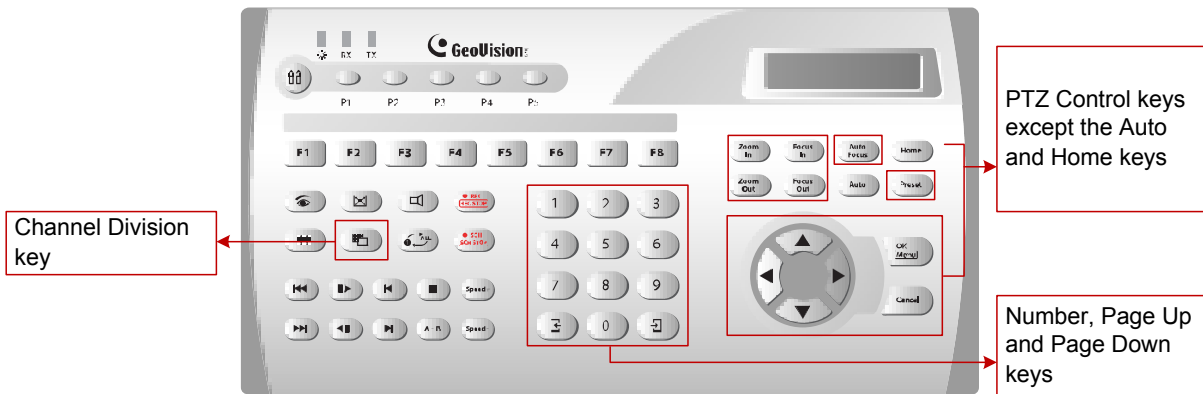

















Figure 22

## 5. Programming and Operation

Function	Procedure
Getting started	Press any key, and enter a password. (The default password is <b>0000</b> .)
Launching Main System	<ol style="list-style-type: none"> <li>1. Press .</li> <li>2. When the message "Multicam System-Please Login!" appears on the screen, press  to open the Login dialog box.</li> <li>3. Select a valid ID, enter a password, and press .</li> </ol>
Launching ViewLog	<ol style="list-style-type: none"> <li>1. Press .</li> <li>2. When the Privilege Confirmation dialog box appears, select a valid ID, enter a password, and press .</li> </ol>
Changing DVR ID	Press <b>P1</b> , and enter a two-digit DVR ID.
Selecting a PTZ camera	Press <b>P2</b> , and press  to select a PTZ camera that you want to control.
Setting up PTZ cameras	Press <b>P4</b> to set up PTZ cameras. For details on the PTZ camera setup, see 3.2 <i>Setting up PTZ Cameras</i> .
Changing password	<ol style="list-style-type: none"> <li>1. Press <b>P3</b>, enter a password, and press  to browse the options on the LCD display.</li> <li>2. When "Password Change" appears, press  and enter a four-digit password.</li> </ol>
Disabling/Enabling key beep	<ol style="list-style-type: none"> <li>1. Press <b>P3</b>, enter a password, and press  to browse the options on the LCD display.</li> <li>2. When "Audio Setting" appears, press  and press  to enable/disable the key beep.</li> </ol>
Setting auto-lock period	<ol style="list-style-type: none"> <li>1. Press <b>P3</b>, enter a password, and press  to browse the options on the LCD display.</li> <li>2. When "Auto Time Lock" appears, press  and enter an idle period after which the Keyboard is automatically locked. * The Keyboard can be used only when the correct password is entered.</li> </ol>



Setting A to B frame for auto-playing	<ol style="list-style-type: none"><li>1. Press . The message "A To B Mode (Set A)" appears on the screen.</li><li>2. Press  again. The message "A To B Mode (Set B)" appears. ViewLog starts playing the set frames A to B repeatedly. * To stop the playing, press . The message "A To B Mode (Cancelled)" will appear.</li></ol>
---------------------------------------	---

## 6. On-Screen Display Menu

In Main System and ViewLog modes, you can press  to call up the on-screen display (OSD) menus.

### 6.1 The OSD Menu in Main System

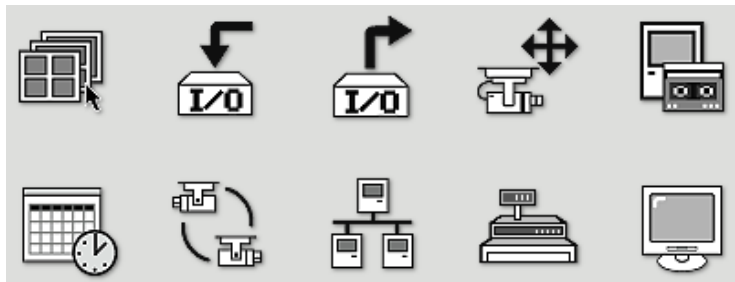















Figure 23

	<p><b>Screen Division</b> Changes the screen divisions.</p>
	<p><b>Input Device</b> Displays all or several input module panels.</p>
	<p><b>Output Device</b> Forces output devices.</p>
	<p><b>PTZ Camera</b> Enables/Disables PTZ camera, Preset Go, Auto (Auto Pan), AF (Auto Focus) and Hide PTZ Panel.</p>
	<p><b>Monitor</b> Starts/Stops monitoring all or some cameras.</p>
	<p><b>Schedule</b> Enables/Disables the schedule.</p>
	<p><b>Camera Scan</b> Enables/Disables the rotation through screen divisions.</p>
	<p><b>Network</b> Enables/Disables remote applications, including Modem Server, TCP Server, Multicast Server, Connect to VSM, Twin Server, WebCam Server and Connect to Center V2.</p>
	<p><b>POS</b> Enables/Disables/Switches multiple POS Live Views.</p> <ol style="list-style-type: none"> <li>1. Press  and press  to enable POS1 Live View.</li> <li>2. Select POS on OSD menu again, select <b>View Mode Switch</b> and press  to enable switching between <b>Show All</b> or <b>Hide All</b> POS Live</li> </ol>

	<p>Views.</p> <p>3. Enter POS again and you can switch to <b>Show All</b> or <b>Hide All</b> to show or hide all POS Live Views or disable the <b>View Mode Switch</b> function. You can only set up one function every time you enter POS. For example, if you have enabled <b>Show All</b> of the POS Live Views but now want to disable POS1 and POS2, you will have to enter POS to disable POS1 and then enter POS again to disable POS2.</p>
	<p><b>Spot Monitor</b></p> <p>Configures settings such as scan and zoom by selecting Spot1 to configure channels 1 to 16 or Spot2 to configure channels 17 to 32.</p>

### 6.1.1 Changing the Main System OSD Options

To change the Main System OSD options with the Keyboard, follow the steps below:

1. Press the **OK/Menu** button to open the OSD (Figure 1).
2. Use the direction buttons to select a menu you want.
3. Press the **OK/Menu** button to open the menu.
4. Use the direction buttons to select a menu option, and then press the **OK/Menu** button to change the setting.







OR

Simply press the **OK/Menu** button to enable or disable an option in the case of Schedule and Camera Scan.

## 6.2 The OSD Menu in ViewLog



Figure 24

	<p><b>Video Event Search</b> Locates a video event.</p> <ol style="list-style-type: none"> <li>1. Press the  and  buttons to move back and forth along the OSD time to select a unit of time. (Month/Date/Year Hr.:Min.:Sec.)</li> <li>2. Use the numeric buttons to enter a desired time or press  and  to change the display time.</li> <li>3. Press the <b>OK/Menu</b> button to view the search result.</li> </ol> <p>If the event at the specified time can't be located, the previous or next video event available will be displayed.</p>
	<p><b>View Mode</b> Changes the view modes, including Single View, Thumbnail View, Quad View and Multi View.</p>
	<p><b>Playback Mode</b> Changes the playback modes, including Real Time, Frame by Frame and Just Key Frame.</p>

### 6.2.1 Changing the ViewLog OSD Options

To change the ViewLog OSD options with the Keyboard, follow the steps below:

1. Press the **OK/Menu** button to open the OSD (Figure 1).
2. Use the direction buttons to select a menu you want.
3. Press the **OK/Menu** button to open the menu.
4. Use the direction buttons to select a menu option, and then press the **OK/Menu** button to change the setting.

## 7. Shortcut Key Conflict Test

This test checks whether the Keyboard keys are conflicting with certain shortcut keys of other applications.

1. Execute **GvKeyTest.exe** from the GV-System folder. This dialog box appears.

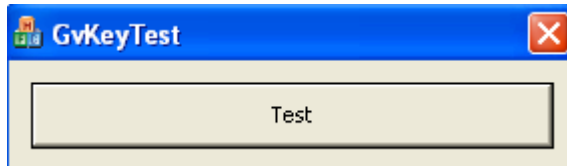

*Figure 25*

2. Click the **Test** button. If there are shortcut key conflicts, a message box similar to the one below appears.



*Figure 26*

3. Disable the shortcut key settings of another application.

## 8. Troubleshooting

Problem	Checklist
No power to Keyboard	<ul style="list-style-type: none"> <li>➤ Check USB connection.</li> <li>➤ If you are using the RS-485 port for connection, make sure to connect the power adaptor.</li> </ul>
Keyboard has power but does not respond to any buttons pressed	<ul style="list-style-type: none"> <li>➤ Check that Keyboard is not locked. See “Getting started”, 5. <i>Programming and Operation</i>.</li> </ul>
Keyboard responds to some, but not all buttons	<ul style="list-style-type: none"> <li>➤ Check if Keyboard keys are conflicting with other applications. See 7. <i>Shortcut Key Conflict Test</i>.</li> </ul>
Message "Connect fail" displays on LCD	<ul style="list-style-type: none"> <li>➤ Verify that the selected ID in Keyboard &amp; Joystick Controller is consistent with the DVR ID. See “Changing DVR ID”, 5. <i>Programming and Operation</i>.</li> <li>➤ Check that the COM port setting in Keyboard &amp; Joystick Controller is correct. See Step 5 of 4.3 <i>Installing USB Driver</i>.</li> <li>➤ If multiple GV-Systems are daisy-chained together,               <ol style="list-style-type: none"> <li>(1) check connections among GV-Systems, and</li> <li>(2) turn on Terminal Resistance to increase frequency response.</li> </ol> </li> <li>➤ If you are using the wall terminal block, make sure               <ol style="list-style-type: none"> <li>(1) terminal screws are not loose, and</li> <li>(2) the cables are attached to the appropriate terminal screws. See 3.3 <i>Wall Terminal Block</i>.</li> </ol> </li> </ul>
Keyboard LEDs are not visible	<ul style="list-style-type: none"> <li>➤ Yellow POWER LED: check the power source.</li> </ul> <p>When you press a key and the RX or TX LED does not light up,</p> <ul style="list-style-type: none"> <li>➤ Red RX LED: check the connection between the Keyboard and GV-System.</li> <li>➤ Green TX LED: check if the Keyboard is malfunctioning.</li> </ul>

## Specifications

<b>System Requirements</b>	Windows XP / Vista / 7 / Server 2008	
<b>Connection</b>	USB	USB 2.0
	DVR/RS-485+ DVR/RS-485-	Connects to GV-NET card, GV-NET/IO card, GV-Hub or GV-COM
	PTZ/RS-485+ PTZ/RS-485-	Connects to PTZ cameras
	PTZ/RS-422+ PTZ/RS-422-	
<b>Communication</b>	RS-485	9,600 bps (between the keyboard and GV-System)
	RS-485 / 422	2,400 ~ 115,200 bps (between the keyboard and PTZ cameras)
<b>Power</b>	DC IN	DC 12V 1A
<b>Environmental Conditions</b>	Operation temperature	0 °C ~ 50 °C / 32 °F ~ 122 °F
	Humidity	5 % ~ 95 % (non-condensing)
<b>Dimensions (L x W x H)</b>	161 x 300 x 45 mm / 6.34 x 11.81 x 1.77 in	
<b>Note:</b> Currently, GV-Keyboard V3 does not support embedded operating systems.		

## Appendix

### Supported PTZ Protocols and Brands

You can directly set up and control the following PTZ protocols and Brands through the GV-Keyboard V3.

COP 53
COP 55
DongYang
Dynacolor
Linlin
Messoa D
Messoa P
Pelco D
Pelco P
Samsung
Sensormatic
VIDO
Visca
<b>Note:</b> The GV-Keyboard V3 only supports original factory models. Other brands of cameras claiming of the same protocol compatibility may not work properly with GV-Keyboard V3. GeoVision takes no responsibility of such incompatibility.